



AN CƯỜNG[®]
Wood - Working Materials

Giải pháp gỗ nội thất cho mọi nhà

Hettich
Made in Germany



PHỤ KIỆN HOÀN THIỆN NỘI THẤT SỐ MỘT THẾ GIỚI
từ Cộng Hoà Liên Bang Đức
đã có mặt tại Việt Nam



FURNITURE FITTINGS

Bảng Giá
Price List
Ver01-2019

2019

Technik für Möbel

Hettich - a family owned company

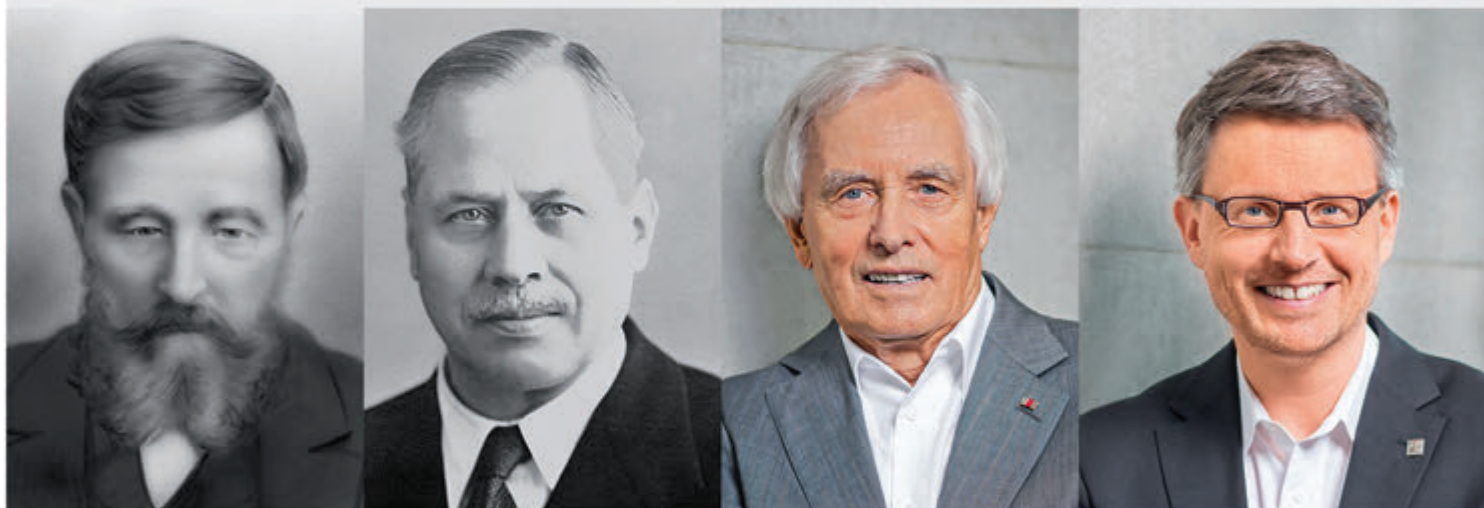

Outstanding engineering achievements. Entrepreneurial courage. And a reliable instinct for the needs of the market. These are the cornerstones of Hettich's success – the same ones we've been building on for over 125 years. Back in 1888 Karl Hettich designed a machine that revolutionised the production of anchor escapements for Black Forest cuckoo clocks. In 1928, August Hettich turned towards the furniture industry with an innovative production line for piano hinges.

Encouraged by further achievements, brothers Paul, August and Franz Hettich set up a new company at Herford in 1930. Kirchlegern became headquarters in 1966. Our company has been a wholly owned family business ever since – now with Dr. Andreas Hettich at the helm as the fourth generation managing direct

Technology for furniture – our passion for over a century. Throughout the world, the Hettich brand stands for quality, innovation, reliability and closeness to customers. Some 6,000 people at Hettich develop intelligent technology for furniture – with renewed commitment every day. Hettich is at home in Kirchlegern, Germany, where we create compelling solutions for people around the globe – solutions that make a big difference in furniture and in people's lives.



GIỚI THIỆU

Với lịch sử hình thành và phát triển hơn 125 năm, hettich trở thành một trong những nhà sản xuất hàng đầu về phụ kiện cho ngành nội thất. Sản phẩm mang thương hiệu Hettich từ cộng hoà liên bang đức đã chiếm lĩnh một thị phần không thể thiếu trong sân chơi phụ kiện đầy tính sáng tạo với sự tuyệt vời về chất lượng và đa dạng về mẫu mã, kiểu dáng.

Đa số các công ty sản xuất tủ bếp hàng đầu thế giới đều sử dụng phụ kiện của Hettich vì đó là sản phẩm tốt nhất trên thế giới hiện nay.

Công ty cổ phần gỗ an cường là nhà cung cấp hàng đầu về vật liệu décor và trang trí nội thất ở việt nam đã được Hettich tin tưởng và chỉ định làm nhà phân phối độc quyền tại việt nam từ ngày 20.08.2014.

Với kho hàng trữ sản phẩm lên đến hàng triệu usd cả hơn 10 showroom trưng bày khắp cả nước. Bao gồm các loại bản lề, ray hộp, ray âm, tay nâng, cửa lùa, cửa ngăn phòng, tay nắm và các loại phụ kiện khác. Tất cả các phẩm hettich đều có xuất xứ từ cộng hoà liên bang đức.

Sự hợp tác của hai công ty hàng đầu, cùng với đội ngũ tư vấn, kỹ thuật bán hàng chuyên nghiệp, giàu kinh nghiệm, chúng tôi cam kết sẽ mang đến cho quý vị những dịch vụ và sản phẩm đẳng cấp nhất.

INTRODUCTION

Hettich's become one of the top accessories for furniture manufacture with more than 125 years of establishment and development. Hettich's products from the Federal Republic of Germany controls the necessary share market in accessories for furniture with the excellent and various design.

Most of the kitchen cabinet manufactures use Hettich's accessories due to its best quality all over the world.

An Cuong Wood Working Joint Stock Company is the best provider in Vietnam about décor materials and furniture decoration, and it's also nominated as the exclusive distributor in vietnam from Aug 20 th, 2014 by Hettich.

We've got the million - dollar storages, 10 showrooms throughout the country. they include hinges, runners, drawers, sliding doors, handles,... and other accessories, which are made in Germany.

The cooperation between the two companies together with the experienced marketing and technology team, we promise customers the best service and the most perfect furniture products.



LGA QualiTest GmbH

Quality Certificate



The LGA QualiTest GmbH
A member of the LGA* - Group
(LGA - a public corporation)
confirms herewith that the company

Hettich International
32269 Kirchzellern

has their products

Hinge „Intermat 9943“ with „Silent System“

tested/inspected and permanently supervised within the scope of a surveillance agreement according to the conditions as laid down in the general contract.
The quality requirements as mentioned below are fully met.

Quality requirements	Results:
Strength, functionality	Compliance in accordance with RAL-GZ 430 1A-1B; DIN 68 857; DIN EN 14 749 and LGA requirements.
Durability	80 000 cycles
Safety	Verified for domestic, kitchen, bath and contract use.
Design, functionality, mounting	Design proved to be functional, comfort of mounting, major comfort of operation due to adjustable damper.
Quality assurance	Internal and external

Nuremberg, 17.07.2008
translated, 31.08.2008
modified, 10.10.2008



Quality Certificate no. 1383
LGA-Test Report no. 736 1383

ppa. *W. Schubert*
Dr.-Ing. W. Schubert
Certification Body

Dr.-Ing. (FH) R. Heyn
Head of the Furniture Testing Institute



LGA QualiTest GmbH

Quality Certificate



The LGA QualiTest GmbH
confirms herewith that the company

Hettich
32278 Kirchzellern

has their products

hinge with integrated damper system "Sensys"

tested/inspected and permanently supervised within the scope of a surveillance agreement according to the conditions as laid down in the general contract.
The quality requirements as mentioned below are fully met.

Quality requirements	Results:
Strength, functionality	Compliance in accordance with RAL-GZ 430 1-2; DIN EN 15579 level 3; DIN EN 14 749 and LGA requirements.
Durability	80 000 cycles with 2x 1 kg additional load
Horizontal load	80N
Vertical load	330N
Safety	Verified for kitchen, domestic, bath and contract use.
Design, functionality, mounting	Design proved to be functional, comfort of mounting, major comfort of operation due to the integrated damper.
Quality assurance	Internal and external

Nuremberg, 22.07.2008

Quality Certificate no. 1538
LGA-Test Report no. 939 1505

ppa. *W. Schubert*
Dr.-Ing. W. Schubert
Certification Body



Dr.-Ing. (FH) R. Heyn
Head of the Furniture Testing Institute



LGA QualiTest GmbH

Quality Certificate



The LGA QualiTest GmbH
A member of the LGA* - Group
(LGA - a public corporation)
confirms herewith that the enterprise

Hettich Management Service GmbH
Systementwicklung u. Normung
32278 Kirchzellern

arranges for testing and controlling continuously the products

Ball-bearing slide "KA 270 / 500"

acc. to the conditions laid down in the general contract.
The quality criteria listed below are fully met.

Quality Characteristics	Data / Facts
Strength, stability	Meets the requirements according to DIN 68 930, ed. 01 1989, kitchen furniture as well as LGA-standards
Durability	60 000 cycles
Nominal load / Test load	50 N / 120 N
Load on front and rear panel	80 N
Opening and closing safety for drawers and slides	Operability after running against stops at a closing speed / opening speed of v = 0.5 m/s external and internal control
Quality assurance	Internal and external

Nuremberg, 21.06.1993
changed, 27.09.2004

Quality Certificate no. 473
test report no. 333 1199 9

ppa. *W. Schubert*
Dr.-Ing. W. Schubert
Certification Body



Dr.-Ing. (FH) R. Heyn
Head of the Furniture Testing Institute



LGA QualiTest GmbH

Quality Certificate



The LGA QualiTest GmbH
A member of the LGA* - Group
(LGA - a public corporation)
confirms herewith that the company

Hettich International
32269 Kirchzellern

has their products

Quadro Full extension V6 EB 20 with Silent System

tested/inspected and permanently supervised within the scope of a surveillance agreement according to the conditions as laid down in the general contract.
The quality requirements as mentioned below are fully met.

Quality requirements	Results
Strength, load capacity	In compliance with RAL-GZ 430 - 1B; DIN 68 856; and LGA requirements for kitchen furniture.
Durability	60 000 cycles
Proof load	30 kg
Dynamic load capacity	Pull-out strength up to 1.04 m/s and requirements according to DIN EN 14 749 are fulfilled.
Safety / handling	Design and function proved to have met the relevant safety requirements
Functionality and mounting	Function proved to be safe, comfort of operation with silent system (close function).
Quality assurance	Internal and external (third party control)

Nuremberg, 04.05.2006
translated, 31.08.2006

Quality Certificate no. 1379
LGA-Test Report no. 736 1153

ppa. *W. Schubert*
Dr.-Ing. W. Schubert
Certification Body



Dr.-Ing. (FH) R. Heyn
Head of the Furniture Testing Institute



Made in Germany

Technik für Möbel



Danh mục | Contents

7
BẢN LỀ
HINGES

21
RAY HỘP
DRAWERS

43
GIẢI PHÁP
TỦ BẾP TRÊN
THE BEST SOLUTION
FOR KITCHEN
CABINET DOOR

47
CỬA TRƯỢT
SLIDING DOORS

69
PHỤ KIỆN
ACCESSORIES

83
TAY NẮM
DECORATIVE
FURNITURE
HANDLES

35
RAY ÂM
RUNNERS

YouTube

www.bit.ly/hettich-ancuong

or scan



Hettich App (Ứng dụng Hettich)

Các danh mục sản phẩm mới nhất, tạp chí, hướng dẫn hoặc video giới thiệu phụ kiện của Hettich. Bạn có thể tìm chúng dễ dàng hơn và nhanh hơn. Đơn giản chỉ cần tải về ứng dụng Hettich từ App Store.

Whether it's the latest catalogue, magazines, instructions or videos you Hettich want - you can now get them even easier and faster. Simply download the Hettich App from the App Store.





BẢN LỀ HINGES

► **SENSYS**



None closes more quietly: sensys has revolutionized the world of hinges. The integrated hidden Silent System mechanism puts an end to banging doors. A gentle flick of the wrist is enough to let cabinet doors close gently,

soundlessly and with a large self-closing range of approx 35°. The design too sets new aesthetic standards. Furniture technology can be as sensuous as this.

► **Sensys fast-assembly concealed hinge with integrated soft-close**

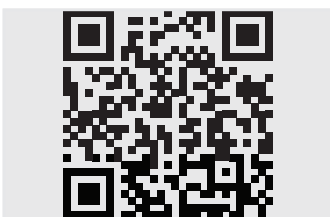

For further information please use the QR code above or the following link:
www.hettich.com/short/69f25f



Less work!
No adjustment necessary. No matter whether large or heavy, the door always closes reliably and gently, thanks to the unusually wide automatic angled plate of 35°.



Maximum customer satisfaction!
No doors slamming when it's hot, no doors left standing open when it's cold. Sensys is optimised for reliable performance over a wide temperature range of + 5°C to + 40°C.

BẢN LÈ "SENSYS" CÓ TÍCH HỢP GIẢM CHẤN, MÀU ĐEN, 110°
 SENSYS HINGE IN OBSIDIAN BLACK WITH INTEGRATED SYSTEM, 110°



Mô Tả Description	Nhóm Group	Mã SP Cat. No	Mã Đặt Hàng Order. No	Giá bán/Cái Price/Pc
Bản lề trùm ngoài Full overlay	1	9 091 738	HB 110-F	96,000
Bản lề trùm nửa Half overlay	1	9 091 739	HB 110-H	98,000
Bản lề lọt lòng Inset	1	9 091 740	HB 110-I	100,000

- Sử dụng cho cánh cửa dày 15-24mm
 For door thickness 15-24mm

ĐỂ BẢN LÈ "SENSYS"
 SENSYS MOUNTING PLATE



Mô Tả Description	Nhóm Group	Mã SP Cat. No	Mã Đặt Hàng Order. No	Giá bán/Cái Price/Pc
Đế bản lề, có ốc điều chỉnh, màu đen Mounting plate with screws in obsidian black	1	9 091 800	SP110-SB	9,600

NẮP LOGO CHO TAY BẢN LÈ "SENSYS"
 COVER CAP FOR SENSYS HINGE ARM



Mô Tả Description	Nhóm Group	Mã SP Cat. No	Mã Đặt Hàng Order. No	Giá bán/Cái Price/Pc
Nắp logo gắn cho tay bản lề, màu đen Cover cap in obsidian black for hinge arm	1	9 091 821	SP110-BB	3,400

NẮP CHO CHÉN BẢN LÈ "SENSYS"
 COVER CAP FOR HINGE CUP



Mô Tả Description	Nhóm Group	Mã SP Cat. No	Mã Đặt Hàng Order. No	Giá bán/Cái Price/Pc
Nắp gắn trên chén bản lề, màu đen Cover cap in obsidian black for hinge cup	1	9 091 822	SP110-CB	5,800

BẢN LỀ "SENSYS" CÓ TÍCH HỢP GIẢM CHẤN 110°
SENSYS HINGE WITH INTEGRATED SILENT SYSTEM, 110°

HOT

Mô Tả Description	Nhóm Group	Mã SP Cat. No	Mã Đặt Hàng Order. No	Giá bán/Cái Price/Pc
Bản lề trùm ngoài Full overlay	1	9 071 205	HP 110 - F	88,000

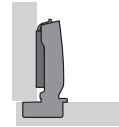

Bản lề trùm nửa Half overlay	1	9 071 206	HP 110 - H	96,000
--------------------------------	---	-----------	------------	--------



Bản lề lọt lòng Inset	1	9 071 207	HP 110 - I	104,000
-------------------------	---	-----------	------------	---------

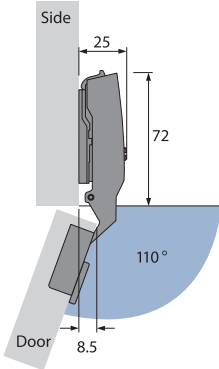

- Sử dụng cho cánh cửa dày 15-24mm
For door thickness 15-24mm

BẢN LỀ "SENSYS" KHÔNG TÍCH HỢP GIẢM CHẤN 110°
SENSYS HINGE WITHOUT SILENT SYSTEM, 110°



Mô Tả Description	Nhóm Group	Mã SP Cat. No	Mã Đặt Hàng Order. No	Giá bán/Cái Price/Pc
Bản lề trùm ngoài Full overlay	1	9 071 259	HPN 110 - F	66,000
Bản lề trùm nửa Half overlay	1	9 071 260	HPN 110 - H	72,000
Bản lề lọt lòng Inset	1	9 071 261	HPN 110 - I	78,000

- Sử dụng cho cánh cửa dày 15-24mm
For door thickness 15-24mm

BẢN LỀ "SENSYS" CÓ TÍCH HỢP GIẢM CHẤN 95°, GỖ DÀY ĐẾN 32MM
SENSYS HINGE WITH INTEGRATED SILENT SYSTEM, 95°, DOOR THICKNESS UP TO 32MM

Mô Tả Description	Nhóm Group	Mã SP Cat. No	Mã Đặt Hàng Order. No	Giá bán/Cái Price/Pc
Bản lề trùm ngoài Full overlay	1	9 090 260	HP 032 - F	100,000
Bản lề trùm nửa Half overlay	1	9 090 270	HP 032 - H	108,000
Bản lề lọt lòng Inset	1	9 090 280	HP 032 - I	116,000

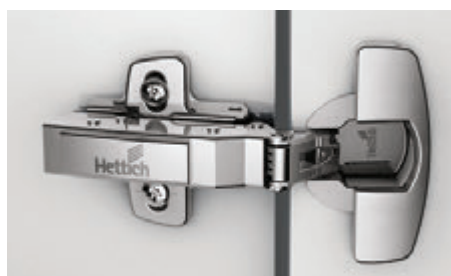
- Sử dụng cho cánh cửa dày 15-32mm
For door thickness 15-32mm

BẢN LỀ "SENSYS" KHÔNG TÍCH HỢP GIẢM CHẤN 95°, GỖ DÀY ĐẾN 32MM
SENSYS HINGE WITHOUT INTEGRATED SILENT SYSTEM, 95°, DOOR THICKNESS UP TO 32MM

Mô Tả Description	Nhóm Group	Mã SP Cat. No	Mã Đặt Hàng Order. No	Giá bán/Cái Price/Pc
Bản lề trùm ngoài Full overlay	1	9 090 350	HPN 032 - F	72,000
Bản lề trùm nửa Half overlay	1	9 090 360	HPN 032 - H	80,000
Bản lề lọt lòng Inset	1	9 090 370	HPN 032 - I	88,000

- Sử dụng cho cánh cửa dày 15-32mm
For door thickness 15-32mm

ĐỂ BÀN LỀ “SENSYS”, CÓ ỐC ĐIỀU CHỈNH ĐỘ CAO
SENSYS MOUNTING PLATE, WITH PILOT PIN AND SPECIAL SCREWS

Mô Tả Description	Nhóm Group	Mã SP Cat. No	Mã Đặt Hàng Order. No	Giá bán/Cái Price/Pc
Đế bàn lề, có ốc điều chỉnh độ cao Mounting plate, with pilot pin and special screws	1	9 071 651	SP 110 - P	18,000

ĐỂ BÀN LỀ “SENSYS”
SENSYS MOUNTING PLATE

Mô Tả Description	Nhóm Group	Mã SP Cat. No	Mã Đặt Hàng Order. No	Giá bán/Cái Price/Pc
Đế bàn lề Mounting plate	1	9 071 576	SP 110 - S	9,600

NẮP LOGO CHO TAY BÀN LỀ “SENSYS”
COVER CAP FOR SENSYS HINGE ARM

Mô Tả Description	Nhóm Group	Mã SP Cat. No	Mã Đặt Hàng Order. No	Giá bán/Cái Price/Pc
Nắp logo gắn cho tay bàn lề Cover cap for hinge arm	1	9 082 774	SP 110 - B	3,400

NẮP CHO CHÉN BÀN LỀ “SENSYS”
COVER CAP FOR HINGE CUP

Mô Tả Description	Nhóm Group	Mã SP Cat. No	Mã Đặt Hàng Order. No	Giá bán/Cái Price/Pc
Nắp gắn trên chén bàn lề Cover cap for hinge cup	1	9 082 614	SP 110 - C	5,800

► **INTERMAT**



Intermat is the handy and versatile hinge for fast assembly. It is particularly easy to fit and can be adjusted without effort. Intermat hinges can be used for virtually every application.

Intermat offers tangible convenience in everyday use. With the optional Silent System, it lets cabinet doors close without a sound.

► **Intermat fast assembly concealed hinge**

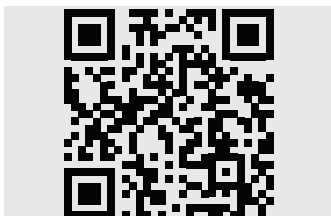

for further information please use the QR code above or the following link:
www.hettich.com/short/69f25f



Typically InterMAT:
The ergonomic clip on installation. Quick and astoudingly easy.



The Silent System is easily retrofitted:
It is simply clipped or screwed on or secured to the hinge cup.

BẢN LỀ “INTERMAT 110°”
INTERMAT HINGE, 110°



Mô Tả Description	Nhóm Group	Mã SP Cat. No	Mã Đặt Hàng Order. No	Giá bán/Cái Price/Pc
Bản lề trùm ngoài Full overlay	1	1 029 518	HS 110 - F	32,000
Bản lề trùm nửa Half overlay	1	1 030 620	HS 110 - H	36,000
Bản lề lọt lòng Inset	1	1 030 922	HS 110 - I	40,000

• Sử dụng cho cánh cửa dày 15-25mm
For door thickness 15-25mm

BẢN LỀ “INTERMAT 110°”, NHẤN MỞ
INTERMAT HINGE, 110°, PUSH TO OPEN



Mô Tả Description	Nhóm Group	Mã SP Cat. No	Mã Đặt Hàng Order. No	Giá bán/Cái Price/Pc
Bản lề trùm ngoài Full overlay	1	0 060 200	HD 110 - F	32,000
Bản lề trùm nửa Half overlay	1	0 060 201	HD 110 - H	36,000
Bản lề lọt lòng Inset	1	0 060 202	HD 110 - I	40,000

• Sử dụng với nút nhấn mở tủ nam châm "Magnet" (trang 19)
Compatible with push to open Magnet (page 19)

BẢN LỀ “INTERMAT 165°”
INTERMAT HINGE, 165°



Mô Tả Description	Nhóm Group	Mã SP Cat. No	Mã Đặt Hàng Order. No	Giá bán/Cái Price/Pc
Bản lề trùm ngoài Full overlay	1	9 099 750	HS 165 - F	112,000
Bản lề trùm ngoài, nhấn mở Full overlay, push to open	1	0 040 301	HD 165 - F	116,000

• Sử dụng cho cánh cửa dày 16-24mm
For door thickness 16-24mm

BẢN LỀ “INTERMAT 65°” CHO CỬA TỦ GÓC
INTERMAT HINGE, 65° FOR CORNER CABINET FOLDING DOORS



Mô Tả Description	Nhóm Group	Mã SP Cat. No	Mã Đặt Hàng Order. No	Giá bán/Cái Price/Pc
Bản lề trùm ngoài Full overlay	1	0 045 036	HD 065 - F	104,000

• Sử dụng cùng với bản lề InterMat 165° cho cửa tủ góc
Use with InterMat 165° for corner cabinet folding doors

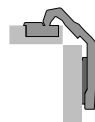

BẢN LÊ “INTERMAT 95°”, GỖ DÀY ĐẾN 43MM
 INTERMAT HINGE 95°, DOOR THICKNESS UP TO 43MM

Mô Tả Description	Nhóm Group	Mã SP Cat. No	Mã Đặt Hàng Order. No	Giá bán/Cái Price/Pc
Bản lề trùm ngoài Full overlay	1	9 155 241	HD 043 - F	98,000
Bản lề trùm nửa Half overlay	1	9 155 242	HD 043 - H	100,000
Bản lề lọt lòng Inset	1	9 155 243	HD 043 - I	107,000

- Sử dụng cho cánh cửa dày 16-43mm
For door thickness 16-43mm

BẢN LÊ “INTERMAT GÓC MÙ 95°”
 INTERMAT BLIND CORNER HINGE, 95° OPENING

Mô Tả Description	Nhóm Group	Mã SP Cat. No	Mã Đặt Hàng Order. No	Giá bán/Cái Price/Pc
Bản lề cho góc mù For 90° face angles	1	0 077 708	HD 000 - F	98,000

- Sử dụng cho cánh cửa dày 14-28mm
For door thickness 14-28mm

ĐỂ BẢN LÊ “INTERMAT”
 INTERMAT MOUNTING PLATE

Mô Tả Description	Nhóm Group	Mã SP Cat. No	Mã Đặt Hàng Order. No	Giá bán/Cái Price/Pc
Đế bản lề Mounting plate	1	1 071 606	SP 110 - I	5,500

Number of hinges per door

Door width, height and weight as well as the material quality of the door are decisive factors determining the number of hinges required.

The factors encountered in practice differ widely from case to case. For this reason, the number of hinges specified in the diagram must be understood as a guide only. If in doubt, it is recommended to carry out a trial installation and adjust the number of hinges as necessary. For reasons of stability, space X between the hinges must always be made as large as possible. The space X must be at least 280 mm.

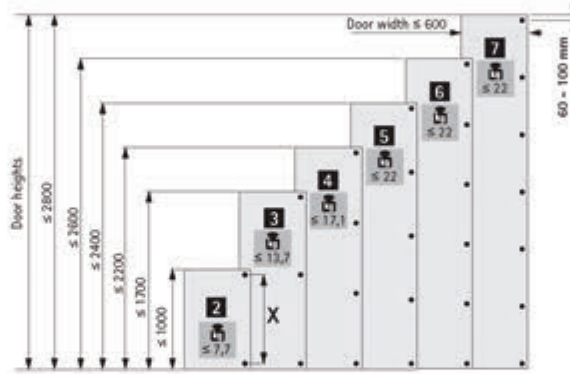

The online catalogue now comes with the new hinge configurator that lets you find the right solution quickly and reliably. You can then order your products straight away and access CAD drawings through HettCAD.



Our online catalogue lets you gather information on Hettich products and prices 24 hours a day.

Simply enter www.hettich.com/en/online, complete the registration process and you can immediately take advantage of the functions and all of the services provided.

1 Mapping folder
This is where all chosen articles are collected for purchasing. The order can be divided into several consignments.

2 Flip-page catalogue
You can browse through the electronic product catalogue online or download it as the basis of a PDF file.

3 Article information
On every product, all information at a glance, in the flip-page catalogue or in PDF format.

4 Installation instructions
Instructions displayed in detail make installation easier and more secure.

5 Product video
Drawing hour with the product's assembly and installation videos from Hettich.

6 Drilling patterns
All relevant drilling data at a glance, also for down-sizing (up / down).

7 Drilling patterns 2D (ISO)
Suitable for exporting to CNC machines.

8 Article data 2D / 3D
CAD data for downloading directly (step 1, 4th).

9 3D assembly view
Shows a preview of the 3D model.

10 HettCAD
CAD data (2D and 3D) are available in over 80 formats for downloading.

11 Master data
This is where you will find all relevant details on packaging size, packaging unit and other technical information.

12 Accessories
The right accessories for every article. Clearly presented, all options at a glance.

► **SLIDE-ON**

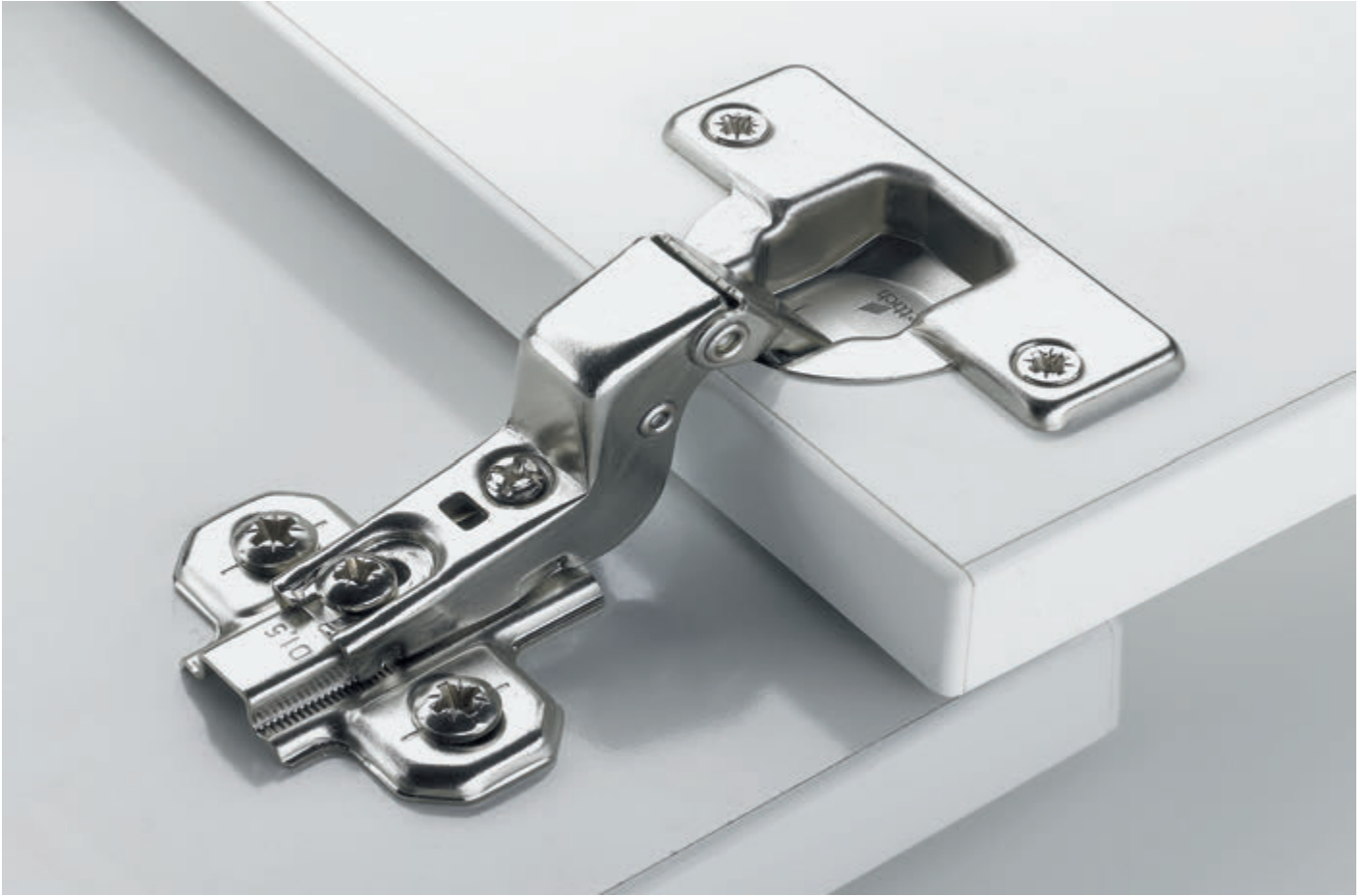

Easy installation and convenience in standard applications: fitting. Its double spring action lets SlideOn Open and close SliceOn from Hettich. With the high quality of an all-steel cabinet doors safely at all times.

► **Slide on concealed hinge SlideOn**

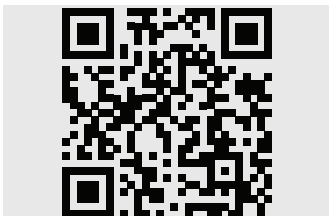

For further information please use the QR code above or the following link:
www.hettich.com/short/69f25f



95° opening angle with double spring action.



Slide on system for easy installation.

BẢN LỀ “SLIDE-ON 95°”
SLIDE-ON HINGE 95°

Mô Tả Description	Nhóm Group	Mã SP Cat. No	Mã Đặt Hàng Order. No	Giá bán/Cái Price/Pc
Bản lề trùm ngoài Full overlay	1	1 078 660	HE 095 - F	13,000
Bản lề trùm nửa Half overlay	1	1 078 661	HE 095 - H	15,000
Bản lề lọt lòng Inset	1	1 078 662	HE 095 - I	17,000

- Sử dụng cho cánh cửa dày 14-25mm
For door thickness 14-25mm

ĐỂ BẢN LỀ “SLIDE-ON”
SLIDE-ON MOUNTING PLATE

Mô Tả Description	Nhóm Group	Mã SP Cat. No	Mã Đặt Hàng Order. No	Giá bán/Cái Price/Pc
Đế bản lề Mounting plate	1	1 079 198	SP 095 - I	4,800

► SILENT SYSTEM



NÊM GIẢM CHẤN GẮN TRÊN TAY BẢN LÊ "INTERMAT" CLIP ON SILENT SYSTEM



Mô Tả Description	Nhóm Group	Mã SP Cat. No	Mã Đặt Hàng Order. No	Giá bán/Cái Price/Pc
Trùm ngoài Full overlay	2	0 060 576	SI 518 - F	74,000
Trùm nửa Half overlay	2	0 060 577	SI 620 - H	84,000
Lọt lồng Inset	2	0 060 578	SI 922 - I	94,000

NÊM GIẢM CHẤN GẮN TRÊN CHÉN BẢN LÊ "SLIDE-ON" HINGE CUP SILENT SYSTEM



Mô Tả Description	Nhóm Group	Mã SP Cat. No	Mã Đặt Hàng Order. No	Giá bán/Cái Price/Pc
Lắp trên chén bản lề Hinge cup silent system	2	0 060 581	SI 007 - A	43,000

NÊM GIẢM CHẤN BẮT VÀO LỖ KHOAN UNIVERSAL DRILL IN SILENT SYSTEM



Mô Tả Description	Nhóm Group	Mã SP Cat. No	Mã Đặt Hàng Order. No	Giá bán/Cái Price/Pc
Bắt vào lỗ khoan, cửa nặng đến 7 kg Drilling into carcass panel, for door weight up to 7kg	2	0 060 685	SI 007 - W	32,000

- Sử dụng 2 giảm chấn cho cửa nặng hơn 7.5 kg
Use 2 silent system for door weighing over 7.5 kg

NÊM GIẢM CHẤN BẮT VÀO VÁCH TỦ UNIVERSAL SCREW ON SILENT SYSTEM



Mô Tả Description	Nhóm Group	Mã SP Cat. No	Mã Đặt Hàng Order. No	Giá bán/Cái Price/Pc
Bắt vào vách tủ Screw-mounting to carcass panel	2	0 060 687	SI 007 - C	34,000

- Sử dụng 2 giảm chấn cho cửa nặng hơn 7.5 kg
Use 2 silent system for door weighing over 7.5 kg

► PUSH TO OPEN

NÚT NHẤN MỞ TỬ “MAGNET” PUSH TO OPEN MAGNET



Mô Tả Description	Nhóm Group	Mã SP Cat. No	Mã Đặt Hàng Order. No	Giá bán/Bộ Price/Set
Nhấn mở cánh cửa tủ cao 300-900 mm Push to open for door height 300-900 mm	2	0 060 230	PA 109 - W	93,000

- Phù hợp cho bản lề nhấn mở - thiết kế không tay nắm
Suitable for push to open hinges - handleless furniture fronts

ĐỂ CHO NÚT NHẤN MỞ TỬ “MAGNET” SCREW ON ADAPTER FOR PUSH TO OPEN MAGNET



Mô Tả Description	Nhóm Group	Mã SP Cat. No	Mã Đặt Hàng Order. No	Giá bán/Cái Price/Pc
Bắt vào vách tủ Screw-mounting to carcass panel	2	0 060 231	PA 109 - C	9,200

NÚT NHẤN MỞ TỬ “UNIVERSAL MINI” PUSH TO OPEN UNIVERSAL MINI



Mô Tả Description	Nhóm Group	Mã SP Cat. No	Mã Đặt Hàng Order. No	Giá bán/Cái Price/Pc
Nhấn mở cánh cửa tủ cao 300-1600 mm Push to open for door height 300-1600 mm	2	9 089 602	PA 209 - B	100,000

- Phù hợp cho bản lề bật Intermat, Slide On - thiết kế không tay nắm
Suitable for spring hinges Intermat, Slide On - handleless furniture fronts

NÚT NHẤN MỞ TỬ “UNIVERSAL MAXI” PUSH TO OPEN UNIVERSAL MAXI



Mô Tả Description	Nhóm Group	Mã SP Cat. No	Mã Đặt Hàng Order. No	Giá bán/Bộ Price/Set
Nhấn mở cánh cửa tủ cao 300-2400 mm Push to open for door height 300-2400 mm	2	0 060 233	PA 209 - A	89,700

- Phù hợp cho bản lề bật Intermat, Slide On - thiết kế không tay nắm
Suitable for spring hinges Intermat, Slide On - handleless furniture fronts

INNOTECH the height of individuality

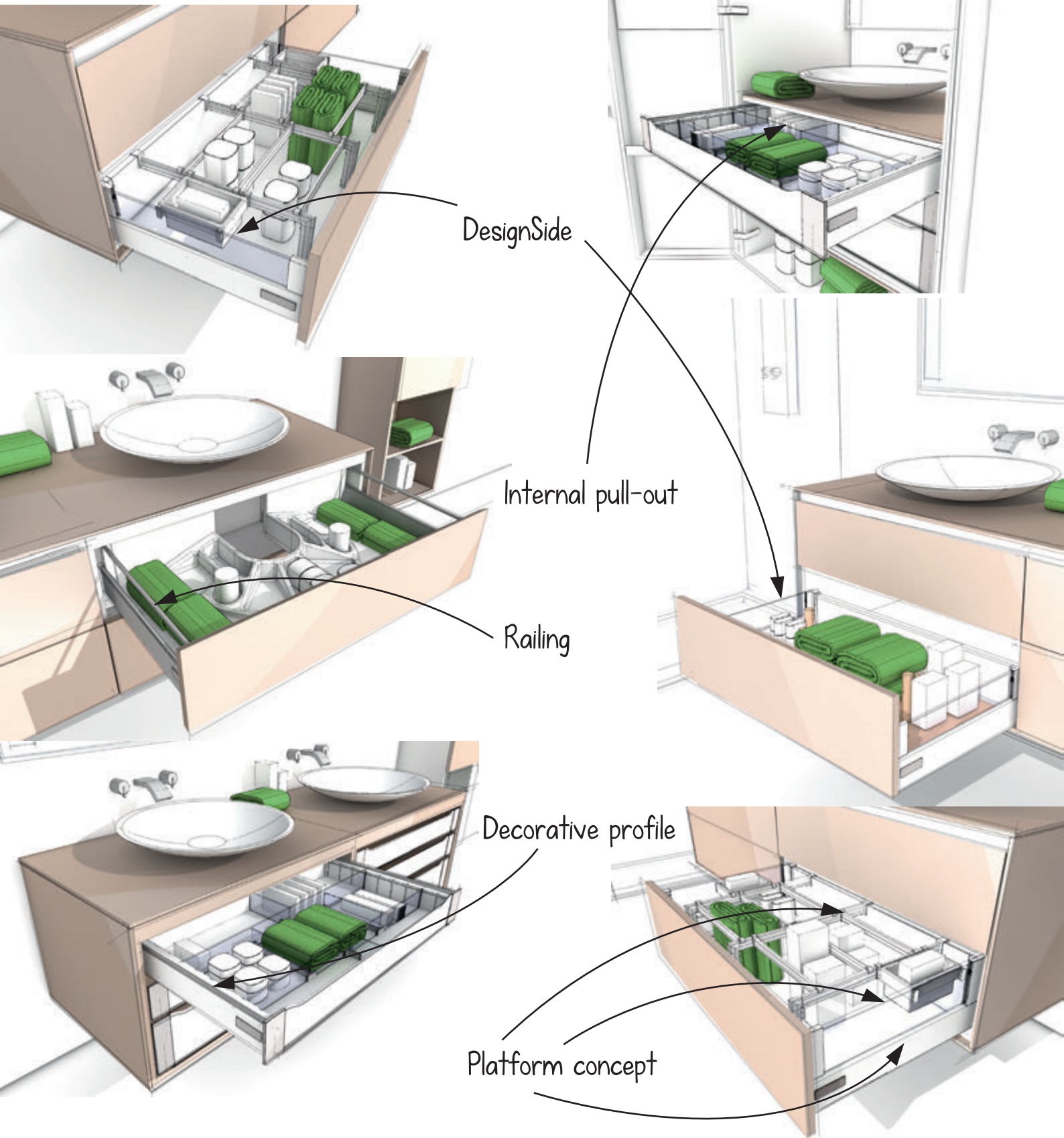



RAY HỘP DRAWERS

▶ **INNOTECH ATIRA - SILVER**



Markant, vielseitig, flexibel - das Schubkastensystem InnoTech Atira überzeugt auf den ersten Blick. Kantige Konturen, verschiedene Farbvarianten und facettenreiche Aufsatzelemente offenbaren jede Menge Gestaltungspotential.

Hinzu kommen vielfältige Lösungen zur Innenorganisation. All das auf Basis von nur einer Plattform: Mehr Individualität kann ein Schubkastensystem nicht bieten.



Ausgezeichnet:
Klare Formensprache trifft auf bewährte Technik. InnoTech Atira präsentiert sich mit charaktvoller Kante und starker Leistung.



Perfektes Zusammenspiel aus jedem Blickwinkel:
Alle Komponenten sind farblich aufeinander abgestimmt.



Markante Linien außen, strukturierte Organisation innen:
Mithilfe vieler praktischer Details und Funktionen wird der Stauraum komplett ausgenutzt. Und Sie haben beim Blick in den Schubkasten die volle Übersicht.

RAY HỘP “INNOTECH ATIRA H70” - MÀU BẠC
INNOTECH ATIRA DRAWER SLIDE SYSTEM H70 - SILVER COLOR



Mô Tả Description	Nhóm Group	Mã SP Cat. No	Mã Đặt Hàng Order. No	Giá bán/Bộ Price/Set
a/ Ray âm dài 470mm bên trái & phải (1 cặp) Drawer runner L & R (1 pair)	1	9 118 054 9 118 055	IT SA1 - 070	840,000
b/ Thành hộp bên trái & phải (1 cặp) Drawer side profile L & R (1 pair)		9 194 398 9 194 399		
c/ Khớp nối trước (2 cái) Drawer front connector for side profile (2 pcs)		1 065 191		
d/ Nắp đậy logo Hettich (2 cái) Cover cap (2 pcs)		9 194 646		
e/ Khớp nối sau bên trái & phải (1 cặp) Rear panel connector L & R (1 pair)		1 062 501 1 062 502		

- Cao 70mm, tải trọng 30kg, màu bạc, giảm chấn
Height 70mm, loading 30kg, Silver color, silent system

RAY HỘP “INNOTECH ATIRA H144” - MÀU BẠC
INNOTECH ATIRA DRAWER SLIDE SYSTEM H144 - SILVER COLOR



Mô Tả Description	Nhóm Group	Mã SP Cat. No	Mã Đặt Hàng Order. No	Giá bán/Bộ Price/Set
Khớp nối trước của thanh nâng cấp (2 cái) Drawer front connector for lengthwise railing (2 pcs)	1	9 002 503	IT SA1 - 144	1,080,000
Thanh nâng cấp ray hộp trái/phải (2 thanh) Lengthwise railing L & R (2 bars)		9 194 530 9 194 531		
Khớp nối sau bên trái & phải (1 cặp) Rear panel connector L & R (1 pair)		9 007 355 9 007 356		
Các thành phần khác: (a) + (b) + (c) + (d) trang 23 Other components: (a) + (b) + (c) + (d) page 23		-		

- Cao 144mm, tải trọng 30kg, màu bạc, giảm chấn
Height 144mm, loading 30kg, silver color, silent system

RAY HỘP “INNOTECH ATIRA H176” - MÀU BẠC
INNOTECH ATIRA DRAWER SLIDE SYSTEM H176 - SILVER COLOR



Mô Tả Description	Nhóm Group	Mã SP Cat. No	Mã Đặt Hàng Order. No	Giá bán/Bộ Price/Set
Khớp nối thanh nâng cấp (4 cái) Drawer front connector for lengthwise railing (4pcs)	1	9 002 503	IT SA1 - 176	1,300,000
Thanh nâng cấp ray hộp trái/phải bên dưới (2 thanh) Lengthwise railing L&R bottom (2 bars)		9 194 530 9 194 531		
Thanh nâng cấp ray hộp trái/phải bên trên (2 thanh) Lengthwise railing L&R top (2 bars)		9 195 018 9 195 019		
Khớp nối sau bên trái & phải (1 cặp) Rear panel connector L & R (1 pair)		9 027 831 9 027 832		
Các thành phần khác: (a) + (b) + (c) + (d) trang 23 Other components: (a) + (b) + (c) + (d) page 23		-		

- Cao 176mm, tải trọng 30kg, màu bạc, giảm chấn
Height 176mm, loading 30kg, silver color, silent system

Giá và hình ảnh mang tính chất tham khảo | The price and pictures is for reference

Bảng giá chưa bao gồm thuế VAT 10% và phí vận chuyển
The prices are not include 10% VAT and transportation fee

RAY HỘP ÂM “INNOTECH ATIRA H70” - MÀU BẠC
INNOTECH ATIRA INTERNAL DRAWER SLIDE SYSTEM H70 - SILVER COLOR

Mô Tả Description	Nhóm Group	Mã SP Cat. No	Mã Đặt Hàng Order. No	Giá bán/Bộ Price/Set
Thanh nhôm mặt trước dài 1000mm (1 thanh) Aluminium front, length 1000mm (1 bar)	1	9 194 764	IT SA2 - 070	2,220,000
Bas nối cho thanh nhôm mặt trước (1 cặp) Connector for aluminium front (1 pr)		9 104 107		
Các thành phần khác: (a) + (b) + (d) + (e) trang 23 Other components: (a) + (b) + (d) + (e) page 23		-		

• Cao 70mm, tải trọng 30kg, màu bạc, giảm chấn
Height 70mm, loading 30kg, silver color, silent system

RAY HỘP ÂM “INNOTECH ATIRA H144” - MÀU BẠC
INNOTECH ATIRA INTERNAL DRAWER SLIDE SYSTEM H144 - SILVER COLOR

Mô Tả Description	Nhóm Group	Mã SP Cat. No	Mã Đặt Hàng Order. No	Giá bán/Bộ Price/Set
Thanh nhôm mặt trước dài 1,000mm (1 thanh) Aluminium front, length 1000mm (1 bar)	1	9 194 764	IT SA2 - 144	2,870,000
Bas nối cho thanh nhôm mặt trước và thanh nâng cấp (1 cặp) Connector for aluminium front and railing (1 pr)		9 204 257		
Thanh nâng cấp 2 bên thành hộc (1cặp) Lengthwise railing (1pair)		9 194 570		
Thanh nâng cấp mặt trước ray hộp 2000mm (1thanh) Lengthwise railing 2000mm (1bar)		9 194 571		
Khớp nối sau bên trái & phải (1 cặp) Rear panel connector L & R (1 pair)		9 194 614		
Các thành phần khác: (a) + (b) + (d) trang 23 Other components: (a) + (b) + (d) page 23		9 007 355 9 007 356		

• Cao 144mm, tải trọng 30kg, màu bạc, giảm chấn
Height 144mm, loading 30kg, silver color, silent system

► **INNOTECH - SILVER**



Attractive designs for living and lifestyle!

There's a special pleasure in working, or simply being, in a kitchen where good design is an intergral feature. And attention to form and function, colour and materials can't stop at the front panels. Prospective kitchen buyers always pull out drawers. InnoTech lets you create a harmonized look & feel throughout the kitchen.

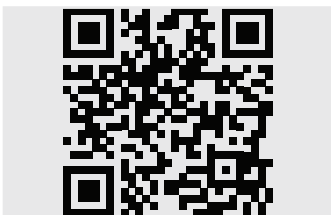

For further information please use the QR code above or the following link:
www.hettich.com/short/69f25f



Simply ingenious:
The Hettich Platform concept. All options are based on a single drawer side profile. Which makes them easy to upgrade.





RAY HỘP “INNOTECH H70” - MÀU BẠC
INNOTECH DRAWER SLIDE SYSTEM H70 - SILVER COLOR



Mô Tả Description	Nhóm Group	Mã SP Cat. No	Mã Đặt Hàng Order. No	Giá bán/Bộ Price/Set
a/ Ray âm dài 470mm bên trái & phải (1 cặp) Drawer runner L & R (1 pair)	1	9 118 054	IT SS1 - 070	840,000
		9 118 055		
b/ Thành hộp bên trái & phải (1 cặp) Drawer side profile L & R (1 pair)		1 062 019		
		1 062 020		
c/ Khớp nối trước (2 cái) Drawer front connector for side profile (2 pcs)		1 065 191		
d/ Nắp đậy logo Hettich (2 cái) Cover cap (2 pcs)	9 079 220			
e/ Khớp nối sau bên trái & phải (1 cặp) Rear panel connector L & R (1 pair)		1 062 501 1 062 502		

• Cao 70mm, tải trọng 30kg, màu bạc, giảm chấn
 Height 70mm, loading 30kg, Silver color, silent system

RAY HỘP “INNOTECH H144” - MÀU BẠC
INNOTECH DRAWER SLIDE SYSTEM H144 - SILVER COLOR



Mô Tả Description	Nhóm Group	Mã SP Cat. No	Mã Đặt Hàng Order. No	Giá bán/Bộ Price/Set
Khớp nối trước của thanh nâng cấp (2 cái) Drawer front connector for lengthwise railing (2 pcs)	1	9 002 503	IT SB1 - 144	1,050,000
Thanh nâng cấp ray hộp (2 thanh) Lengthwise railing (2 bars)		1 062 394		
Khớp nối sau bên trái & phải (1 cặp) Rear panel connector L & R (1 pair)		9 007 355 9 007 356		
Các thành phần khác: (a) + (b) + (c) + (d) trang 27 Other components: (a) + (b) + (c) + (d) page 27		-		

• Cao 144mm, tải trọng 30kg, màu bạc, giảm chấn
 Height 144mm, loading 30kg, silver color, silent system

Cả và hình ảnh mang tính chất tham khảo [The price and pictures is for reference]

Bảng giá chưa bao gồm thuế VAT 10% và phí vận chuyển
 The prices are not include 10% VAT and transportation fee

RAY HỘP "INNOTECH H176" - MÀU BẠC
INNOTECH DRAWER SLIDE SYSTEM H176 - SILVER COLOR



Mô Tả Description	Nhóm Group	Mã SP Cat. No	Mã Đặt Hàng Order. No	Giá bán/Bộ Price/Set
Khớp nối trước của thanh nâng cấp (2 cái) Drawer front connector for lengthwise railing (2 pcs)	1	9 002 503	IT S81 - 176	1,080,000
Thanh nâng cấp ray hộp (2 thanh) Lengthwise railing (2 bars)		1 062 394		
Khớp nối sau bên trái & phải (1 cặp) Rear panel connector L & R (1 pair)		9 027 831 9 027 832		
Các thành phần khác: (a) + (b) + (c) + (d) trang 27 Other components: (a) + (b) + (c) + (d) page 27		-		

- Cao 176mm, tải trọng 30kg, màu bạc, giảm chấn
Height 176mm, loading 30kg, silver color, silent system

RAY HỘP "INNOTECH H144" THÀNH HỘP KÍNH (KHÔNG BAO GỒM KÍNH) - MÀU BẠC
INNOTECH DRAWER SLIDE SYSTEM H144 WITH DESIGN SLIDE (WITHOUT GLASS) - SILVER COLOR

Mô Tả Description	Nhóm Group	Mã SP Cat. No	Mã Đặt Hàng Order. No	Giá bán/Bộ Price/Set
Bas lắp kính dày 6mm (1 bộ) DesignSide adapter (1 set)	1	9 100 878	IT S61 - 144	1,310,000
Khớp nối trước cho bas lắp kính (2 cái) Drawer front connector for DesignSide (2 pcs)		9 098 724		
Khớp nối sau bên trái & phải (1 cặp) Rear panel connector L & R (1 pair)		9 007 355 9 007 356		
Các thành phần khác: (a) + (b) + (c) + (d) trang 27 Other components: (a) + (b) + (c) + (d) page 27		-		

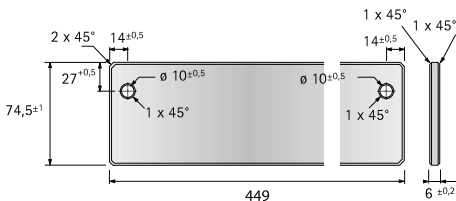
- Cao 144mm, tải trọng 30kg, màu bạc, giảm chấn
Height 144mm, loading 30kg, silver color, silent system



- Kích thước cắt kính
Glass side dimension

RAY HỘP "INNOTECH H176" THÀNH HỘP KÍNH (KHÔNG BAO GỒM KÍNH) - MÀU BẠC
INNOTECH DRAWER SLIDE SYSTEM H176 WITH DESIGN SLIDE (WITHOUT GLASS) - SILVER COLOR

Mô Tả Description	Nhóm Group	Mã SP Cat. No	Mã Đặt Hàng Order. No	Giá bán/Bộ Price/Set
Bas lắp kính dày 6mm (1 bộ) DesignSide adapter (1 set)	1	9 110 993	IT S61 - 176	1,440,000
Khớp nối trước cho bas lắp kính (2 cái) Drawer front connector for DesignSide (2 pcs)		9 098 724		
Khớp nối sau bên trái & phải (1 cặp) Rear panel connector L & R (1 pair)		9 027 831 9 027 832		
Các thành phần khác: (a) + (b) + (c) + (d) trang 27 Other components: (a) + (b) + (c) + (d) page 27		-		

- Cao 176mm, tải trọng 30kg, màu bạc, giảm chấn
Height 176mm, loading 30kg, silver color, silent system

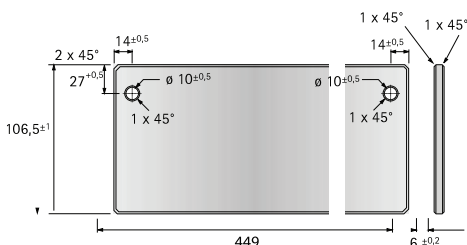

- Kích thước cắt kính
Glass side dimension

RAY HỘP ÂM “INNOTECH H70” - MÀU BẠC
INNOTECH INTERNAL DRAWER SLIDE SYSTEM H70 - SILVER COLOR



Mô Tả Description	Nhóm Group	Mã SP Cat. No	Mã Đặt Hàng Order. No	Giá bán/Bộ Price/Set
Thanh nhôm mặt trước dài 1000mm (1 thanh) Aluminium front, length 1000mm (1 bar)	1	9 104 108-1M	IT SS2 - 070	1,530,000
Bas nối cho thanh nhôm mặt trước (1 cặp) Connector for aluminium front (1 pr)		9 104 107		
Các thành phần khác: (a) + (b) + (d) + (e) trang 27 Other components: (a) + (b) + (d) + (e) page 27		-		

- Cao 70mm, tải trọng 30kg, màu bạc, giảm chấn
Height 70mm, loading 30kg, silver color, silent system

RAY HỘP ÂM “INNOTECH H144” - MÀU BẠC
INNOTECH INTERNAL DRAWER SLIDE SYSTEM H144 - SILVER COLOR



Mô Tả Description	Nhóm Group	Mã SP Cat. No	Mã Đặt Hàng Order. No	Giá bán/Bộ Price/Set
Thanh nhôm mặt trước dài 1,000mm (1 thanh) Aluminium front, length 1000mm (1 bar)	1	9 104 108-1M	IT SB2 - 144	2,220,000
Thanh nâng cấp mặt hộc trước 1,141mm (1 thanh) Railing for aluminium front (1 bar)		1 074 009		
Bas nối cho thanh nhôm mặt trước (1 cặp) Connector for aluminium front (1 pair)		9 104 118		
Thanh nâng cấp 2 bên thành hộc (2 thanh) Lengthwise railing (2 bars)		9 086 247		
Khớp nối sau bên trái & phải (1 cặp) Rear panel connector L & R (1 pair)		9 007 355 9 007 356		
Các thành phần khác: (a) + (b) + (d) trang 27 Other components: (a) + (b) + (d) page 27		-		

- Cao 144mm, tải trọng 30kg, màu bạc, giảm chấn
Height 144mm, loading 30kg, silver color, silent system

► **INNOTECH - WHITE**



Finishing kitchen ranges in differing levels of quality. Serving the market with diversity. While still keeping production and inventory lean. Not a problem with the InnoTech drawer system. Because you can create numerous options on the basis of just one drawer side profile. The flexible and efficient way.

**One side profile, many options:
InnoTech**

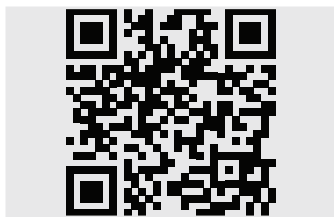

For further information please use the QR code above or the following link:
www.hettich.com/short/69f25f



Simply ingenious:
The Hettich Platform concept. All options are based on a single drawer side profile. Which makes them easy to upgrade.



InnoTech stands for excellent ergonomics. It makes all the difference to have a clear overview and easy access to everything in the drawer.



RAY HỘP “INNOTECH H70” - MÀU TRẮNG
 INNOTECH DRAWER SLIDE SYSTEM H70 - WHITE COLOR



Mô Tả Description	Nhóm Group	Mã SP Cat. No	Mã Đặt Hàng Order. No	Giá bán/Bộ Price/Set
a/ Ray âm dài 470mm bên trái & phải (1 cặp) Drawer runner L & R (1 pair)	1	9 118 054	IT WS1 - 070	840,000
		9 118 055		
b/ Thành hộp bên trái & phải (1 cặp) Drawer side profile L & R (1 pair)		1 062 454		
		1 062 455		
c/ Khớp nối trước (2 cái) Drawer front connector for side profile (2 pcs)		1 065 191		
d/ Nắp đậy logo Hettich (2 cái) Cover cap (2 pcs)	9 104 095			
e/ Khớp nối sau bên trái & phải (1 cặp) Rear panel connector L & R (1 pair)		1 062 503 1 062 504		

- Cao 70mm, tải trọng 30kg, màu trắng, giảm chấn
 Height 70mm, loading 30kg, white color, silent system

RAY HỘP “INNOTECH H144” - MÀU TRẮNG
 INNOTECH DRAWER SLIDE SYSTEM H144 - WHITE COLOR



Mô Tả Description	Nhóm Group	Mã SP Cat. No	Mã Đặt Hàng Order. No	Giá bán/Bộ Price/Set
Khớp nối trước của thanh nâng cấp (2 cái) Drawer front connector for lengthwise railing (2 pcs)	1	9 002 503	IT WB1 - 144	1,050,000
Thanh nâng cấp ray hộp (2 thanh) Lengthwise railing (2 bars)		1 062 549		
Khớp nối sau bên trái & phải (1 cặp) Rear panel connector L & R (1 pair)		9 060 648 9 060 649		
Các thành phần khác: (a) + (b) + (c) + (d) trang 31 Other components: (a) + (b) + (c) + (d) page 31		-		

- Cao 144mm, tải trọng 30kg, màu trắng, giảm chấn
 Height 144mm, loading 30kg, white color, silent system

Giá và hình ảnh mang tính chất tham khảo | The prices and pictures is for reference

Bảng giá chưa bao gồm thuế VAT 10% và phí vận chuyển
 The prices are not include 10% VAT and transportation fee

RAY HỘP "INNOTECH H176" - MÀU TRẮNG
INNOTECH DRAWER SLIDE SYSTEM H176 - WHITE COLOR



Mô Tả Description	Nhóm Group	Mã SP Cat. No	Mã Đặt Hàng Order. No	Giá bán/Bộ Price/Set
Khớp nối trước của thanh nâng cấp (2 cái) Drawer front connector for lengthwise railing (2 pcs)	1	9 002 503	IT WB1 - 176	1,080,000
Thanh nâng cấp ray hộp (2 thanh) Lengthwise railing (2 bars)		1 062 549		
Khớp nối sau bên trái & phải (1 cặp) Rear panel connector L & R (1 pair)		9 086 932 9 086 933		
Các thành phần khác: (a) + (b) + (c) + (d) trang 31 Other components: (a) + (b) + (c) + (d) page 31		-		

- Cao 176mm, tải trọng 30kg, màu trắng, giảm chấn
Height 176mm, loading 30kg, white color, silent system

RAY HỘP "INNOTECH H144" THÀNH HỘP KÍNH (KHÔNG BAO GỒM KÍNH) - MÀU TRẮNG
INNOTECH DRAWER SLIDE SYSTEM H144 WITH DESIGN SLIDE (WITHOUT GLASS) - WHITE COLOR

Mô Tả Description	Nhóm Group	Mã SP Cat. No	Mã Đặt Hàng Order. No	Giá bán/Bộ Price/Set
Bas lắp kính dày 6mm (1 bộ) DesignSide adapter (1 set)	1	9 100 882	IT WG1 - 144	1,310,000
Khớp nối trước cho bas lắp kính (2 cái) Drawer front connector for DesignSide (2 pcs)		9 098 724		
Khớp nối sau bên trái & phải (1 cặp) Rear panel connector L & R (1 pair)		9 060 648 9 060 649		
Các thành phần khác: (a) + (b) + (c) + (d) trang 31 Other components: (a) + (b) + (c) + (d) page 31		-		

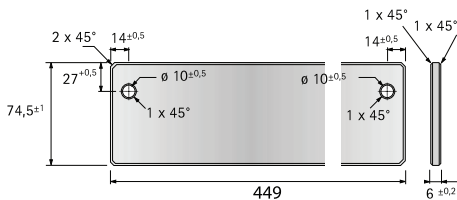
- Cao 144mm, tải trọng 30kg, màu trắng, giảm chấn
Height 144mm, loading 30kg, white color, silent system



- Kích thước cắt kính
Glass side dimension

RAY HỘP "INNOTECH H176" THÀNH HỘP KÍNH (KHÔNG BAO GỒM KÍNH) - MÀU TRẮNG
INNOTECH DRAWER SLIDE SYSTEM H176 WITH DESIGN SLIDE (WITHOUT GLASS) TRẮNG - WHITE COLOR

Mô Tả Description	Nhóm Group	Mã SP Cat. No	Mã Đặt Hàng Order. No	Giá bán/Bộ Price/Set
Bas lắp kính dày 6mm (1 bộ) DesignSide adapter (1 set)	1	9 110 997	IT WG1 - 176	1,440,000
Khớp nối trước cho bas lắp kính (2 cái) Drawer front connector for DesignSide (2 pcs)		9 098 724		
Khớp nối sau bên trái & phải (1 cặp) Rear panel connector L & R (1 pair)		9 086 932 9 086 933		
Các thành phần khác: (a) + (b) + (c) + (d) trang 31 Other components: (a) + (b) + (c) + (d) page 31		-		

- Cao 176mm, tải trọng 30kg, màu trắng, giảm chấn
Height 176mm, loading 30kg, white color, silent system

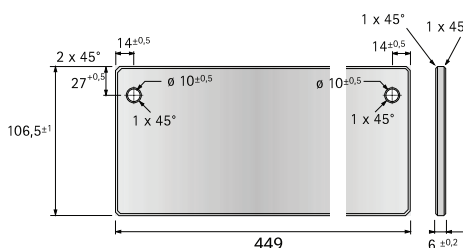

- Kích thước cắt kính
Glass side dimension

RAY HỘP ÂM “INNOTECH H70” - MÀU TRẮNG
INNOTECH INTERNAL DRAWER SLIDE SYSTEM H70TRẮNG - WHITE COLOR



Mô Tả Description	Nhóm Group	Mã SP Cat. No	Mã Đặt Hàng Order. No	Giá bán/Bộ Price/Set
Thanh nhôm mặt trước dài 1000mm (1 thanh) Aluminium front, length 1000mm (1 bar)	1	9 104 108	IT WS2 - 070	1,530,000
Bas nối cho thanh nhôm mặt trước (1 cặp) Connector for aluminium front (1 pr)		9 115 501		
Các thành phần khác: (a) + (b) + (d) + (e) trang 31 Other components: (a) + (b) + (d) + (e) page 31		-		

- Cao 70mm, tải trọng 30kg, màu trắng, giảm chấn
Height 70mm, loading 30kg, white color, silent system

RAY HỘP ÂM “INNOTECH H144” MÀU TRẮNG
INNOTECH INTERNAL DRAWER SLIDE SYSTEM H144TRẮNG - WHITE COLOR



Mô Tả Description	Nhóm Group	Mã SP Cat. No	Mã Đặt Hàng Order. No	Giá bán/Bộ Price/Set
Thanh nhôm mặt trước dài 1,000mm (1 thanh) Aluminium front (1 bar)	1	9 104 108	IT WB2 - 144	2,220,000
Thanh nâng cấp mặt hộc trước 1,141mm (1 thanh) Railing for aluminium front (1 bar)		1 074 008		
Bas nối cho thanh nhôm mặt trước (1 cặp) Connector for aluminium front (1 pair)		9 115 502		
Thanh nâng cấp 2 bên thành hộc (2 thanh) Lengthwise railing (2 bars)		9 114 915		
Khớp nối sau bên trái & phải (1 cặp) Rear panel connector L & R (1 pair)		9 060 648 9 060 649		
Các thành phần khác: (a) + (b) + (d) trang 31 Other components: (a) + (b) + (d) page 31	-	-	-	-

- Cao 144mm, tải trọng 30kg, màu trắng, giảm chấn
Height 144mm, loading 30kg, white color, silent system





RAY ÂM RUNNERS

▶ ACTRO 5D DRAWER RUNNER



Precision that excites:

The Actro 5D drawer runner is simply the perfect choice for unique furniture design, narrow reveals and large front panels. Adjusting in 5 directions, front panel alignment meets the most exacting demands.

Excellent running performance and incredible stability provide supreme quality you can feel and hear. Actro 5D is ideal for wooden drawers as well as for the AvanTech drawer system.



Unequalled running action, smooth and synchronised: Actro 5D.



Extremely narrow reveals and precision front panel alignment through 5-way adjustment.



Handleless elegance, utmost convenience: with Push to open Silent.

RAY ACTRO 5D GIẢM CHẤN - NHẤN MỞ TOÀN PHẦN, TẢI TRONG 40 KG
ACTRO 5D FULL EXTENTION DRAWER WITH SILENT SYSTEMS, LOADING CAPACITY 40KG



Mô Tả Description	Nhóm Group	Mã SP Cat. No	Mã Đặt Hàng Order. No	Giá bán/Cặp Price/PR
Kích thước 250mm Drawer length 250mm	1	9 203 401	AT 250 - 4F	1,030,000
Kích thước 300mm Drawer length 300mm	1	9 203 403	AT 300 - 4F	1,050,000
Kích thước 350mm Drawer length 350mm	1	9 203 405	AT 350 - 4F	1,070,000
Kích thước 400mm Drawer length 400mm	1	9 203 407	AT 400 - 4F	1,090,000
Kích thước 450mm Drawer length 450mm	1	9 203 411	AT 450 - 4F	1,100,000
Kích thước 500mm Drawer length 500mm	1	9 203 415	AT 500 - 4F	1,120,000
Kích thước 550mm Drawer length 550mm	1	9 203 421	AT 550 - 4F	1,140,000

RAY ACTRO 5D GIẢM CHẤN - NHẤN MỞ TOÀN PHẦN, TẢI TRONG 60 KG
ACTRO 5D FULL EXTENTION DRAWER WITH SILENT SYSTEMS, LOADING CAPACITY 60KG



Mô Tả Description	Nhóm Group	Mã SP Cat. No	Mã Đặt Hàng Order. No	Giá bán/Cặp Price/PR
Kích thước 400mm Drawer length 400mm	1	9 203 408	AT 400 - 6F	1,290,000
Kích thước 450mm Drawer length 450mm	1	9 203 412	AT 450 - 6F	1,310,000
Kích thước 500mm Drawer length 500mm	1	9 203 416	AT 500 - 6F	1,340,000
Kích thước 550mm Drawer length 550mm	1	9 203 422	AT 550 - 6F	1,360,000

PHỤ KIỆN CHO ACTRO 5D
ACCESSORIES FOR ACTRO 5D



Mô Tả Description	Nhóm Group	Mã SP Cat. No	Mã Đặt Hàng Order. No	Giá bán/Cặp Price/PR
Bộ nhấn mở 40/60 (1 bộ) PTO Silent opening system for Actro 5D (1 set)	1	9 212 301	AT 001 - P	1,150,000

* Chỉ dành cho Actro 5D tải trọng 40 - 60kg
 Note: Use for Actro 5D, loading 40 - 60kg

► **QUADRO**



► **Runners for wooden drawers**

Quadro drawer runners guarantee the ultimate in drawer convenience. With attractive design through concealed installation. With a long service life and unceasing top performance. The robust, resilient runners provide the steel balls with optimum control - for perfect vertical and lateral

stability. The optional Silent System gently shuts drawers in complete silence. The Push to open function automatically opens the pull-out in response to a light press on the front panel - for handleless front panels.

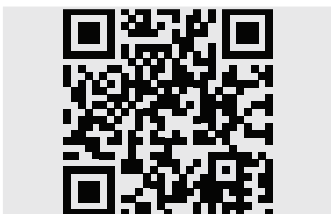

For further information please use the QR code above or the following link:
www.hettich.com/short/8e884c



Push to open:
For drawers that glide out automatically, the perfect solution for handleless fronts.



Even extremely heavy drawers close quietly and gently - thanks to the integrated silent system.

RAY ÂM 'QUADRO' GIẢM CHẤM MỞ 3/4, TẢI TRỌNG 25KG
 PARTIAL EXTENSION RUNNER QUADRO WITH SILENT SYSTEM, LOADING CAPACITY 25KG



Mô Tả Description	Nhóm Group	Mã SP Cat. No	Mã Đặt Hàng Order. No	Giá bán/Cấp Price/PR
Kích thước 300mm Drawer length 300mm	1	9 246 739 9 246 740	QS 300 -P23	270,000
Kích thước 350mm Drawer length 350mm	1	9 246 742 9 246 743	QS 350 -P23	280,000
Kích thước 400mm Drawer length 400mm	1	9 246 744 9 246 745	QS 400 -P23	290,000
Kích thước 450mm Drawer length 450mm	1	9 246 747 9 246 748	QS 450 -P23	300,000
Kích thước 500mm Drawer length 500mm	1	9 246 750 9 246 751	QS 500 -P23	320,000

RAY ÂM 'QUADRO' GIẢM CHẤM MỞ TOÀN PHẦN, TẢI TRỌNG 30KG
 FULL EXTENSION RUNNER QUADRO WITH SILENT SYSTEM, LOADING CAPACITY 30KG



Mô Tả Description	Nhóm Group	Mã SP Cat. No	Mã Đặt Hàng Order. No	Giá bán/Cấp Price/PR
Kích thước 300mm Drawer length 300mm	1	9 246 868 9 246 869	QS 300 -F23	540,000
Kích thước 350mm Drawer length 350mm	1	9 246 871 9 246 872	QS 350 -F23	550,000
Kích thước 400mm Drawer length 400mm	1	9 245 564 9 245 565	QS 400 -F23	580,000
Kích thước 450mm Drawer length 450mm	1	9 246 875 9 246 876	QS 450 -F23	610,000
Kích thước 500mm Drawer length 500mm	1	9 246 889 9 246 890	QS 500 -F23	650,000

RAY ÂM 'QUADRO' KHÔNG GIẢM CHẤM MỞ TOÀN PHẦN, TẢI TRỌNG 30KG
 FULL EXTENSION RUNNER QUADRO WITH STOP CONTROL, LOADING CAPACITY 30KG



Mô Tả Description	Nhóm Group	Mã SP Cat. No	Mã Đặt Hàng Order. No	Giá bán/Cấp Price/PR
Kích thước 350mm Drawer length 350mm	1	1 084 459 1 084 460	QN 350 -F	440,000
Kích thước 400mm Drawer length 400mm	1	1 081 483 1 081 484	QN 400 -F	460,000
Kích thước 450mm Drawer length 450mm	1	1 083 703 1 083 704	QN 450 -F	470,000
Kích thước 500mm Drawer length 500mm	1	1 081 486 1 081 487	QN 500 -F	520,000

Cả và hình ảnh mang tính chất tham khảo | The prices and pictures is for reference

Bảng giá chưa bao gồm thuế VAT 10% và phí vận chuyển
 The prices are not include 10% VAT and transportation fee

RAY ÂM 'QUADRO' NHẤN MỞ, MỞ 3/4, TẢI TRỌNG 25KG

PARTIAL EXTENSION RUNNER QUADRO WITH PUSH TO OPEN, LOADING CAPACITY 25KG



Mô Tả Description	Nhóm Group	Mã SP Cat. No	Mã Đặt Hàng Order. No	Giá bán/Cặp Price/PR
Kích thước 300mm Drawer length 300mm	1	9 246 754 9 246 755	QP 300-P23	300,000
Kích thước 350mm Drawer length 350mm	1	9 246 756 9 246 757	QP 350-P23	310,000
Kích thước 400mm Drawer length 400mm	1	9 246 758 9 246 759	QP 400-P23	330,000
Kích thước 450mm Drawer length 450mm	1	9 246 760 9 246 761	QP 450-P23	350,000
Kích thước 500mm Drawer length 500mm	1	9 246 762 9 246 763	QP 500-P23	370,000

RAY ÂM 'QUADRO' NHẤN MỞ TOÀN PHẦN, TẢI TRỌNG 30KG

FULL EXTENSION RUNNER QUADRO WITH PUSH TO OPEN, LOADING CAPACITY 30KG



Mô Tả Description	Nhóm Group	Mã SP Cat. No	Mã Đặt Hàng Order. No	Giá bán/Cặp Price/PR
Kích thước 300mm Drawer length 300mm	1	9 246 895 9 246 896	QP 300-F23	590,000
Kích thước 350mm Drawer length 350mm	1	9 246 897 9 246 898	QP 350-F23	610,000
Kích thước 400mm Drawer length 400mm	1	9 246 899 9 246 900	QP 400-F23	640,000
Kích thước 450mm Drawer length 450mm	1	9 246 901 9 246 902	QP 450-F23	680,000
Kích thước 500mm Drawer length 500mm	1	9 246 903 9 246 904	QP 500-F23	730,000

BỘ KHÓA CHO RAY ÂM

CATCH FOR WOODEN DRAWERS



Mô Tả Description	Nhóm Group	Mã SP Cat. No	Mã Đặt Hàng Order. No	Giá bán/Cặp Price/PR
Khóa trái Left catch Khóa phải Right catch	1	9 144 830 9 144 841	RS 002-A	29,000

► FULL EXTENSION BALL BEARING RUNNER

RAY BI 3 TẦNG GIẢM CHẤN MỞ TOÀN PHẦN, TẢI TRỌNG 40 KG FULL EXTENSION BALL BEARING RUNNER WITH SILENT SYSTEMS, LOADING CAPACITY 40 KG



Mô Tả Description	Nhóm Group	Mã SP Cat. No	Mã Đặt Hàng Order. No	Giá bán/Cặp Price/PR
Kích thước 300mm Drawer length 300mm	2	9 128 579 (9 221 513)	BS 300 - F	275,000
Kích thước 350mm Drawer length 350mm	2	9 128 580 (9 221 525)	BS 350 - F	290,000
Kích thước 400mm Drawer length 400mm	2	9 128 581 (9 221 526)	BS 400 - F	300,000
Kích thước 450mm Drawer length 450mm	2	9 128 582 (9 221 527)	BS 450 - F	320,000
Kích thước 500mm Drawer length 500mm	2	9 128 583 (9 221 528)	BS 500 - F	340,000

RAY BI 3 TẦNG MỞ TOÀN PHẦN, TẢI TRỌNG 45 KG FULL EXTENSION BALL BEARING, LOADING CAPACITY 45 KG



Mô Tả Description	Nhóm Group	Mã SP Cat. No	Mã Đặt Hàng Order. No	Giá bán/Cặp Price/PR
Kích thước 250mm Drawer length 250mm	2	1 074 018	BB 250 - F	195,000
Kích thước 300mm Drawer length 300mm	2	1 074 019	BB 300 - F	215,000
Kích thước 350mm Drawer length 350mm	2	1 074 020	BB 350 - F	230,000
Kích thước 400mm Drawer length 400mm	2	1 073 723	BB 400 - F	250,000
Kích thước 450mm Drawer length 450mm	2	1 073 724	BB 450 - F	270,000
Kích thước 500mm Drawer length 500mm	2	1 073 725	BB 500 - F	290,000

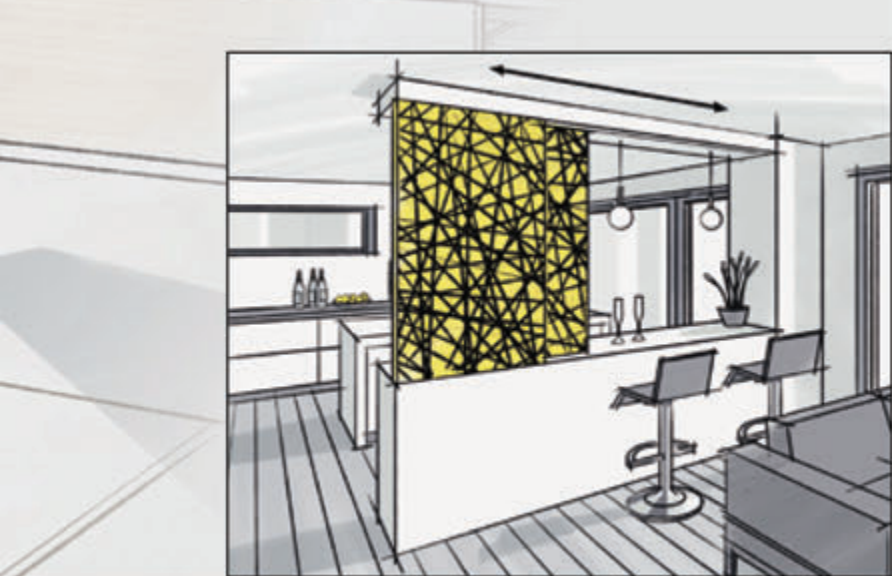



GIẢI PHÁP CHO TỦ BẾP TRÊN
THE BEST SOLUTION FOR KITCHEN CABINET DOOR

► **LIFT ADVANCED**



Incisive technology, outstanding design.

Top level convenience. Selling point for modern kitchens: ergonomic, convenient expectations in no fewer than four ways. Because you can choose from four practicable options. A particular advantage with Lift advanced: the carcass drilling pattern is identical for all four options.

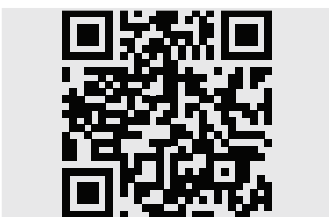

For further information please use the QR code above or the following link:
www.hettich.com/short/1be562



Powerful gas spring let the lift advanced open and close comfortably.



A modern kitchen is expected to be packed with many different functions and ergonomic arrangements.

TAY NÂNG “HK”
LIFT ADVANCED HK



Mô Tả Description	Nhóm Group	Mã SP Cat. No	Mã Đặt Hàng Order. No	Giá bán/Bộ Price/Set
Bộ cánh tay nâng cho chiều cao lọt lòng tủ 276-720 mm (1 bộ) Set of flap fittings for inside carcass height 276-720 mm (1 set)	2	9 079 603	LA 276 - HKS	1,750,000
Pittong 200 N (1 cặp) Gas spring 200 N (1 pr)	2	9 079 619	LA 200 - P	590,000
Pittong 300 N (1 cặp) Gas spring 300 N (1 pr)	2	9 079 624	LA 300 - P	590,000
Pittong 400 N (1 cặp) Gas spring 400 N (1 pr)	2	9 079 628	LA 400 - P	590,000
Pittong 450 N (1 cặp) Gas spring 450 N (1 pr)	2	9 079 630	LA 450 - P	590,000
Pittong 500 N (1 cặp) Gas spring 500 N (1 pr)	2	9 079 632	LA 500 - P	590,000
Pittong 550 N (1 cặp) Gas spring 550 N (1 pr)	2	9 079 635	LA 550 - P	590,000
Pittong 600 N (1 cặp) Gas spring 600 N (1 pr)	2	9 079 637	LA 600 - P	590,000

• Một bộ tay nâng bao gồm: 1 bộ cánh tay nâng, 1 cặp pittong (sẽ được tặng kèm 2 bộ bản lề Intermat (HS 110-F & SP 110-I) - trang 12 & 13)
One set of Lift Advance included: 1 set of flap fittings, 1 pair of gas spring (free of cost 2 sets of Intermat hinges (HS 110-F & SP 110-I) - page 12 & 13)

• Bảng lựa chọn pittong dựa vào chiều cao lọt lòng tủ và khối lượng cánh tủ treo
Table for selecting gas spring based on inside carcass height and flap weight

Chiều cao lọt lòng tủ (mm) Inside carcass height (mm)	276 - 360	361 - 480	481 - 540	541 - 600	601 - 720	Lực nâng của pittong (N) Spring force (N)
Khối lượng cánh tủ treo (kg) Flap weight (kg)	4.1 - 7.0	3.3 - 5.4	2.4 - 4.9	-	-	200
Khối lượng cánh tủ treo (kg) Flap weight (kg)	7.8 - 10.7	5.7 - 7.9	5.2 - 7.6	4.9 - 6.7	4.4 - 5.9	300
Khối lượng cánh tủ treo (kg) Flap weight (kg)	11.5 - 14.3	8.6 - 10.7	8.1 - 10.3	7.2 - 8.8	6.3 - 7.8	400
Khối lượng cánh tủ treo (kg) Flap weight (kg)	13.3 - 16.0	10.2 - 12.1	9.7 - 11.6	8.4 - 10.0	7.3 - 8.7	450
Khối lượng cánh tủ treo (kg) Flap weight (kg)	15.2 - 17.9	11.7 - 13.4	11.0 - 12.8	9.6 - 11.0	8.2 - 9.6	500
Khối lượng cánh tủ treo (kg) Flap weight (kg)	-	12.9 - 14.3	12.4 - 14.1	10.7 - 12.2	9.1 - 10.4	550
Khối lượng cánh tủ treo (kg) Flap weight (kg)	-	14.2 - 15.5	13.7 - 15.4	12.0 - 13.2	10.1 - 12.4	600

TAY NÂNG “HF”
LIFT ADVANCED HF



Mô Tả Description	Nhóm Group	Mã SP Cat. No	Mã Đặt Hàng Order. No	Giá bán/Bộ Price/Set
Bộ cánh tay nâng cho chiều cao lọt lòng tủ 611 - 700 mm (1 bộ) Set of flap fittings for inside carcass height 611 - 700 mm (1 set)	2	9 079 610	LA 611 - HFS	2,250,000
Bộ cánh tay nâng cho chiều cao lọt lòng tủ 701 - 770 mm (1 bộ) Set of flap fittings for inside carcass height 701 - 770 mm (1 set)	2	9 079 614	LA 701 - HFS	2,250,000
Bộ cánh tay nâng cho chiều cao lọt lòng tủ 771 - 925 mm (1 bộ) Set of flap fittings for inside carcass height 771 - 925 mm (1 set)	2	9 079 615	LA 771 - HFS	2,250,000
Pittong 400 N (1 cặp) Gas spring 400 N (1 pr)	2	9 079 628	LA 400 - P	590,000
Pittong 450 N (1 cặp) Gas spring 450 N (1 pr)	2	9 079 630	LA 450 - P	590,000
Pittong 500 N (1 cặp) Gas spring 500 N (1 pr)	2	9 079 632	LA 500 - P	590,000
Pittong 550 N (1 cặp) Gas spring 550 N (1 pr)	2	9 079 635	LA 550 - P	590,000
Pittong 600 N (1 cặp) Gas spring 600 N (1 pr)	2	9 079 637	LA 600 - P	590,000
Pittong 700 N (1 cặp) Gas spring 700 N (1 pr)	2	9 079 645	LA 700 - P	590,000
Pittong 800 N (1 cặp) Gas spring 800 N (1 pr)	2	9 079 650	LA 800 - P	720,000

• Một bộ tay nâng bao gồm: 1 bộ cánh tay nâng, 1 cặp pittong (sẽ được tặng kèm 2 bộ bản lề Intermat (HS 110-F & SP 110-I) - trang 12 & 13)
One set of Lift Advance included: 1 set of flap fittings, 1 pair of gas spring (free of cost 2 sets of Intermat hinges (HS 110-F & SP 110-I) - page 12 & 13)

• Bảng lựa chọn pittong dựa vào chiều cao lọt lòng tủ và khối lượng cánh tủ treo
Table for selecting gas spring based on inside carcass height and flap weight

Chiều cao lọt lòng tủ (mm) Inside carcass height (mm)	611 - 700	701 - 770	771 - 925	Lực nâng của pittong (N) Spring force (N)
Khối lượng cánh tủ treo (kg) Flap weight (kg)	4.6 - 7.0	4.6 - 5.9	4.0 - 5.5	400
Khối lượng cánh tủ treo (kg) Flap weight (kg)	5.9 - 8.0	5.3 - 6.7	4.9 - 6.5	450
Khối lượng cánh tủ treo (kg) Flap weight (kg)	6.9 - 8.9	5.9 - 7.4	5.5 - 7.0	500
Khối lượng cánh tủ treo (kg) Flap weight (kg)	8.0 - 9.9	6.7 - 8.3	6.0 - 7.7	550
Khối lượng cánh tủ treo (kg) Flap weight (kg)	8.8 - 10.8	7.8 - 9.3	6.9 - 8.7	600
Khối lượng cánh tủ treo (kg) Flap weight (kg)	11.1 - 12.9	9.4 - 11.2	8.7 - 10.5	700
Khối lượng cánh tủ treo (kg) Flap weight (kg)	12.6 - 14.4	10.8 - 12.7	10.1 - 11.7	800

HỆ THỐNG CỘT ĐỘNG CƠ ĐIỆN NÂNG HẠ LEGAMOVE, TẢI TRỌNG 40 KG
 LEGAMOVE - ELECTRO MOTORIC COLUMN SYSTEM, LOADING CAPACITY 40KG

Mô Tả Description	Nhóm Group	Mã SP Cat. No	Mã Đặt Hàng Order. No	Giá bán/Bộ Price/Set
Cột nâng hạ 736 - 1225mm (1 cái) Column length 736 - 1225mm (1 pc)	2	9 225 570	LGM - 736	13,500,000
Bộ môđun điện tử vô tuyến (1 bộ) Electronics-Radio-Module		9 227 549		

PITONG HƠI
 LIFT BASIC

Mô Tả Description	Nhóm Group	Mã SP Cat. No	Mã Đặt Hàng Order. No	Giá bán/Cái Price/Pc
Pitong nâng tủ Lift Basic	2	9 079 593	PI 080 - N	140,000

- Tải trọng tối đa 3.2kg/ 2 cái
Max door weight 3.2kg/ 2 pcs
- Kích thước cánh tủ tối đa C400 x R600 mm
Max door dimension H400 x W600 mm

HỆ TRƯỢT CÁNH XẾP CHO TỦ BẾP 4 CÁNH - ĐỘ DÀY CÁNH ĐẾN 19MM
 SLIDING SYSTEM FOR CABINET - DOOR THICKNESS 19MM

Mô Tả Description	Nhóm Group	Mã SP Cat. No	Mã Đặt Hàng Order. No	Giá bán/Bộ Price/Set
Bộ phụ kiện cửa trượt xếp, trái (1 bộ) Set of folding sliding system, left (1 set)	1	0 070 968	WL 770 - 80 B	1,400,000
Bộ phụ kiện cửa trượt xếp, phải (1 bộ) Set of folding sliding system, right (1 set)		0 070 969		
Ray trượt trên, nhôm, 2,000 mm (1 thanh) Top runner profile, alu, 2,000mm (1 pc)		1 079 089 (0 004 311)		
Ray dẫn hướng dưới, nhôm, 2,000 mm (1 thanh) Bottom guide profile, alu, 2,000mm (1 pc)		0 072 919 (0 004 312)		

- Chưa bao gồm bản lề | Not included hinges
- Sử dụng bản lề tích hợp giảm chấn Sensys cho hiệu quả đóng êm tốt nhất (trang 9)
Use Sensys hinges with intergrated Silent system for the best soft closing effect (page 9)

HỆ TRƯỢT CÁNH CHO TỦ BẾP - SLIDE LINE M - ĐỘ DÀY CÁNH ĐẾN 19MM
 SLIDING SYSTEM FOR CABINET - SLIDE LINE M - DOOR THICKNESS 19MM

Mô Tả Description	Nhóm Group	Mã SP Cat. No	Mã Đặt Hàng Order. No	Giá bán/Bộ Price/Set
Bộ phụ kiện cách trượt giảm chấn (1 bộ) Set of fittings for wooden doors with Silent System (soft closing and opening) (1 set)	1	9 156 338	KD 770 - MA	4,600,000
Bộ ray trượt 1 thanh, màu bạc, ván dày 18/19mm, dài 4000mm (1 bộ) Profile set 1 profile, silver, panel thickness 18/19mm, length 4000mm (1 set)		9 209 226		
Bộ thanh trang trí ray, chiều cao ray 18mm, màu bạc, dài 4000mm (1 bộ) Coloured set for concealing the runner profile, profile heigh 18mm, silver, length 4000mm (1 set)		9 209 278		

- Khối lượng cánh tối đa 30kg, Độ rộng cánh từ 450-1800 mm, Chiều cao cánh từ 300-2400mm
Max door weight 30kg, Door width 450-1800mm, Door height 300-2400mm



CỬA TRƯỢT



FOLDING & SLIDING DOOR SYSTEMS

► **INLINE XL**



No handle? No offset? No problem:

The first sliding door system that manages without any handle at all. For the last word in design flexibility. InLine XL lets you create flush fitting unit fronts with the luxurious feel of premium convenience quality: opening in response to a gentle pull on the door's leading edge.

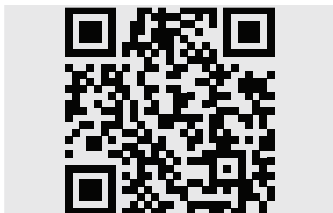

For further information please use the QR code above or the following link:
www.hettich.com/short/b86968



Opens easily, closes gently:
Silent System for first class user convenience on any door.

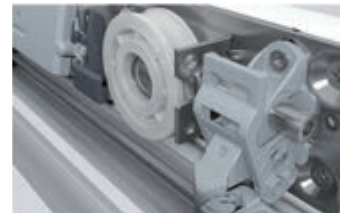

Excellent running action:
Fascinatingly smooth and virtually silent.

BỘ PHỤ KIỆN CỬA TRƯỢT PHẪNG MẶT “INLINE XL” CHO 2 CẢNH, KHỐI LƯỢNG 60KG /CẢNH
SLIDING DOOR SYSTEM INLINE XL FOR 2 DOORS, DOOR WEIGHT 60KG /DOOR



Mô Tả Description	Nhóm Group	Mã SP Cat. No	Mã Đặt Hàng Order. No	Giá bán/Bộ Price/Set
Bộ phụ kiện cửa trượt InLine XL cho 2 cánh, bao gồm giảm chấn Silent System đóng và mở, mỗi cánh cửa rộng từ 750 - 2000 mm InLine XL set of fittings with Silent System for soft opening and closing, door width from 750 - 2000 mm	1	9 148 203	IL 1199 - 060	31,000,000
Bộ hỗ trợ lắp đặt, cánh rộng từ 750 - 2000 mm Mounting aid upgrade kit, door width from 750 - 2000 mm		9 148 562		

- Chiều cao cửa tối đa 2600mm / Chiều rộng cửa từ **750 - 2000 mm** / Độ dày cửa 16 - 25 mm
 Max door height 2600mm / Door width from **750 - 2000 mm** / Door thickness 16 - 25 mm

THÔNG SỐ KỸ THUẬT | TECHNICAL DETAILS

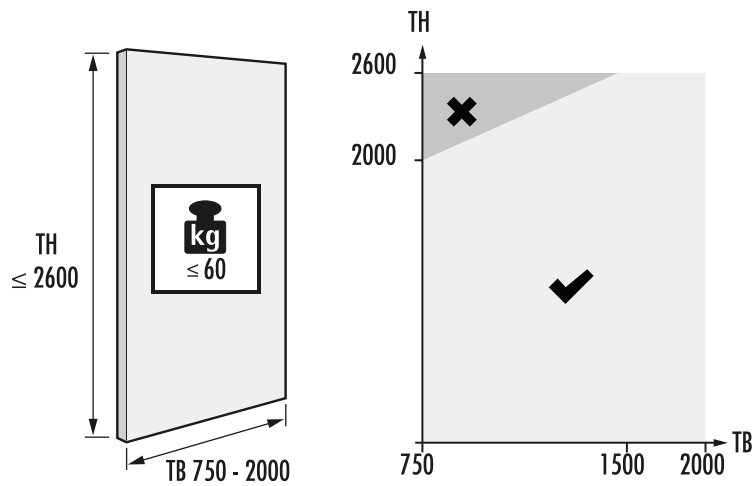

TB	750	950	1150	1500	...	2000
TH ≤	2000	2200	2400	2600	...	2600

► **TOPLINE L**



All-round talent with impressive qualities:

Minimalist design - maximum storage space: Topline L offers you plenty of freedom for large format cabinets. It is notable for the high level of running action, Silent System soft opening and closing action, and easy operation. The running and guiding components are always the same on the TopLine L, whether with a solid or aluminium framed front. this gives you a lot of freedom with carcass construction!

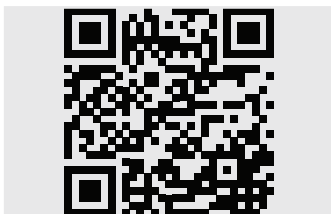

For further information please use the QR code above or the following link:
www.hettich.com/short/304c73



Quiet and gentle:
Silent System evenly opens and closes any sliding door.



Fascinating front panels:
Fully over lapping handleless doors with soft closing and soft opening function.

BỘ PHỤ KIỆN CỬA TRƯỢT "TOPLINE L" TRÙM NGOÀI CHO 2 CẢNH, KHỐI LƯỢNG 50KG/ CẢNH
 SLIDING DOOR SYSTEM TOPLINE FOR 2 DOORS, DOOR WEIGHT 50KGS/ DOOR



CHO CẢNH CỬA DÀY ĐẾN 19MM | FOR MAX. DOOR THICKNESS 19MM

Mô Tả Description	Nhóm Group	Mã SP Cat. No	Mã Đặt Hàng Order. No	Giá bán/Bộ Price/Set
a/ Bộ bánh xe cánh trước (độ dày cửa 19mm) (1 bộ) Set of Topline L for front most door (door thickness 19mm) (1set)	1	9 206 500	TLS 019-50	2,700,000
b/ Bộ bánh xe cánh sau - bên trái (1 bộ) Left rear most door set for offset opening - 1 set		9 206 505		
c/ Bộ phụ kiện mở offset - 2 cánh (1 bộ) Set of accessory for offset opening - 2 doors (1 set)		0 071 111 (0 004 317)		
d/ Ray trượt trên, nhôm 3,000 mm (1 thanh) Top runner profile, alu, 3,000 mm (1 bar)		0 071 117 (0 004 316)		
e/ Ray trượt dưới, nhôm 3,000 mm (1 thanh) Bottom runner profile, alu 3,000 mm (1 bar)	1	9 169 651	ST 019-50A	1,140,000
Bộ phụ kiện giảm chấn cho cửa trượt Topline L 2 cánh (1 bộ) Silent system set for Topline L 2 doors (1 set)				

CHO CẢNH CỬA DÀY ĐẾN 25MM | FOR MAX. DOOR THICKNESS 25MM

Mô Tả Description	Nhóm Group	Mã SP Cat. No	Mã Đặt Hàng Order. No	Giá bán/Bộ Price/Set
Bộ bánh xe cánh trước (độ dày cửa 25mm) - 1 bộ Set of Topline L for front most door (door thickness 25mm) - 1set	1	9 206 502	TLS 025-50	2,780,000
Bộ cơ bản gồm: (b) + (c) + (d) + (e) trang 51 Basic set include: (b) + (c) + (d) + (e) page 51		-		
Bộ phụ kiện giảm chấn cho cửa trượt Topline L 2 cánh (1 bộ) Silent system set for Topline L 2 doors (1 set)	1	9 169 651	ST 019-50A	1,140,000

THÔNG SỐ KỸ THUẬT | TECHNICAL DETAILS

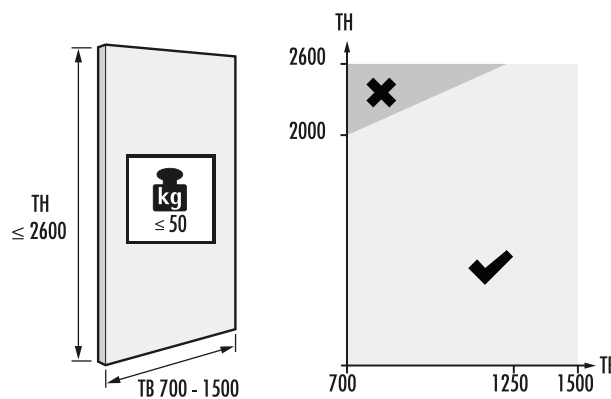

TB	700	800	900	1000	1100	1200	1250	... 1500
TH ≤	2000	2109	2218	2327	2436	2545	2600	... 2600

Giá và hình ảnh mang tính chất tham khảo | The price and pictures is for reference

Bảng giá chưa bao gồm thuế VAT 10% và phí vận chuyển
 The prices are not include 10% VAT and transportation fee

BỘ PHỤ KIỆN CỬA TRƯỢT "TOPLINE L" TRÙM NGOÀI CHO 3 CÁNH DÀY ĐẾN 19MM, KHỐI LƯỢNG 50KG/ CÁNH
 SLIDING DOOR SYSTEM TOPLINE FOR 3 DOORS, MAX. DOOR THICKNESS 19MM, DOOR WEIGHT 50KGS/ DOOR

Mô Tả Description	Nhóm Group	Mã SP Cat. No	Mã Đặt Hàng Order. No	Giá bán/Bộ Price/Set
Bộ bánh xe cánh sau - bên phải (1bộ) Right rear most door set for offset opening (1set)	1	9 206 506	TLS 019-3D	3,400,000
Bộ phụ kiện mở offset - 3 cánh (1 bộ) Set of accessory for offset opening - 3 doors (1set)		9 206 310		
Bộ cơ bản gồm: (a) + (b) + (d) + (e) trang 51 Basic set include: (a) + (b) + (d) + (e) page 51		-		
Bộ phụ kiện giảm chấn cho cửa trượt Topline L 3 cánh (1bộ) Silent system set for Topline L 3 doors (1set)	1	9 169 653	ST 019-3DA	1,160,000
Bộ phụ kiện giảm chấn cho cánh giữa cửa trượt Topline L 3 cánh, dày 19-25mm (1 bộ) Silent System Flexible 50 set for door center Topline L, 3 doors, door thickness 19-25mm (1set)	1	9 140 438	ST 019-CD	840,000

- Chiều cao cửa tối đa 2600mm / Chiều rộng cửa từ 700-1500mm
Max door height 2600mm / Door width from 700-1500mm

BỘ PHỤ KIỆN CỬA TRƯỢT "TOPLINE L" TRÙM NGOÀI CHO 3 CÁNH DÀY ĐẾN 25MM, KHỐI LƯỢNG 50KG/ CÁNH
 SLIDING DOOR SYSTEM TOPLINE FOR 3 DOORS, MAX. DOOR THICKNESS 25MM, DOOR WEIGHT 50KGS/ DOOR

Mô Tả Description	Nhóm Group	Mã SP Cat. No	Mã Đặt Hàng Order. No	Giá bán/Bộ Price/Set
Bộ bánh xe cánh trước (độ dày cửa 25mm) - 1bộ Set of Topline L for front most door (door thickness 25mm) - 1set	1	9 206 502	TLS 025-3D	3,600,000
Bộ bánh xe cánh sau - bên phải (1bộ) Right rear most door set for offset opening (1set)		9 206 506		
Bộ phụ kiện mở offset - 3 cánh (1 bộ) Set of accessory for offset opening - 3 doors (1set)		9 206 310		
Bộ cơ bản gồm: (b) + (d) + (e) trang 51 Basic set include: (b) + (d) + (e) page 51		-		
Bộ phụ kiện giảm chấn cho cửa trượt Topline L 3 cánh (1bộ) Silent system set for Topline L 3 doors (1 set)	1	9 169 653	ST 019-3DA	1,160,000
Bộ phụ kiện giảm chấn cho cánh giữa cửa trượt Topline L 3 cánh, dày 19-25mm (1bộ) Silent System Flexible 50 set for door center Topline L, 3 doors, door thickness 19-25mm (1set)	1	9 140 438	ST 019-CD	840,000

- Chiều cao cửa tối đa 2600mm / Chiều rộng cửa từ 700-1500mm
Max door height 2600mm / Door width from 700-1500mm

BỘ PHỤ KIỆN CỬA TRƯỢT "TOPLINE L" TRÙM NGOÀI CHO 4 CÁCH, KHỐI LƯỢNG 50KG/ CÁCH, CHO CÁCH CỬA DÀY ĐẾN 19MM
SLIDING DOOR SYSTEM TOPLINE FOR 4 DOORS, DOOR WEIGHT 50KGS/ DOOR, DOOR THICKNESS 19MM



Mô Tả Description	Nhóm Group	Mã SP Cat. No	Mã Đặt Hàng Order. No	Giá bán/Bộ Price/Set
Bộ bánh xe cánh trước (độ dày cửa 19mm) (2 bộ) Set of Topline L for front most door (door thickness 19mm) (1set)	1	9 206 500	TLS 019 - 4D	7,000,000
Bộ bánh xe cánh sau - bên trái (1 bộ) Left rear most door set for offset opening (1 set)		9 206 505		
Bộ bánh xe cánh sau - bên phải (1 bộ) Right rear most door set for offset opening (1 set)		9 206 506		
Bộ phụ kiện mở offset (2 bộ) - 2 cánh Set of accessory for offset opening (2 sets)		9 206 309		
Bộ phụ kiện ray dẫn trên (1 bộ) - dài : 4000mm Set of top runner profile (1 set) - length: 4000mm		9 185 715		
Ray dẫn dưới - dài 6000mm Bottom runner profile (1 bar) - length 6000mm		0 046 419 (0 004 316)		
Bộ phụ kiện giảm chấn đóng bên trên cho cánh trước (1 bộ) Silent system soft closing set for offset opening (1 set)	1	9 169 651	ST 019 - 50A	1,140,000
Bộ nâng cấp giảm chấn đóng bên trên cho cánh sau (1 bộ) Upgrade set for silent system soft closing set for offset opening (1 set)	1	9 169 653	ST 019 - 3DA	1,160,000
Bộ phụ kiện giảm chấn mở bên trên (2 cánh - 19mm) (1 bộ) Silent system soft opening set for offset opening (1 set)	1	9 169 637	ST 019 - 4A	1,120,000
Bộ giảm chấn cho bộ phận dẫn hướng bên dưới (1 bộ) Silent system soft guiding set (1 sets)	1	9 199 769	ST 019 - 4D	400,000

- Nên sử dụng 2 bộ giảm chấn ST 019 - 4D
Two silent system soft guiding sets (ST 019 - 4D) are required
- Chiều cao cửa tối đa 2600mm / Chiều rộng cửa từ 700 - 1500mm
Max door height 2600mm / Door width from 700 - 1500mm

THÔNG SỐ KỸ THUẬT | TECHNICAL DETAILS

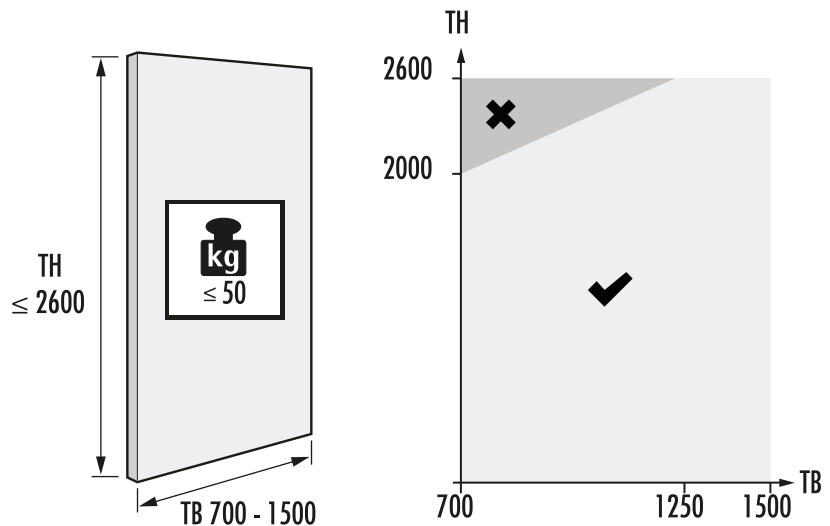

TB	700	800	900	1000	1100	1200	1250	... 1500
TH ≤	2000	2109	2218	2327	2436	2545	2600	... 2600

► **TOPLINE 27**



TopLine 27 are universal sliding door systems and the preferred option for bedroom furniture. Weighing 25 kg, the sliding doors can be combined with a 1 or 2-track guide system – adapting them to suit the chosen plinth design



Top running door set Topline 27 - For 2 and 3 sliding doors, simple carcass construction

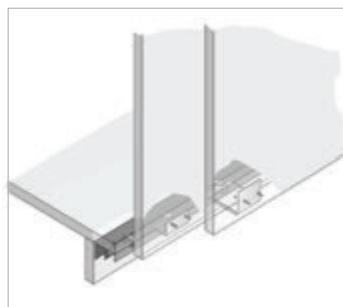

Bottom door guide



The adaptive Silent System gives doors the luxurious option of gentle closure.

BỘ PHỤ KIỆN CỬA TRƯỢT “TOPLINE 27” CHO 2 CÁNH DÀY ĐẾN 19MM, KHỐI LƯỢNG 25KG/ CÁNH
SLIDING DOOR SYSTEM TOPLINE 27 FOR 2 DOORS, DOOR THICKNESS 19MM, DOOR WEIGHT 25KG/ DOOR



Mô Tả Description	Nhóm Group	Mã SP Cat. No	Mã Đặt Hàng Order. No	Giá bán/Bộ Price/Set
Bộ bánh xe treo trên (1 bộ) Set of top running components (1 set)	1	0 026 082	TLS 719-25	2,070,000
Bộ bánh xe bên dưới (1 bộ) Set of bottom running components (1 set)		0 045 080		
Ray trượt trên, nhôm, 3000 mm (1 thanh) Top runner profile, alu, 3000mm (1 bar)		0 046 417 (0 000 837)		
Ray trượt dưới, nhôm, 3000 mm (1 thanh) Bottom runner profile, alu, 3000mm (1 bar)		0 071 117 (0 004 316)		
Bộ phụ kiện giảm chấn, cho cửa TopLine 27, 2 cánh, dày 19mm (1 bộ) Silent system set for TopLine 27, 2 doors, door thickness 19mm (1 set)	1	9 079 733	ST 719-25	810,000

- Chiều cao cửa tối đa 2000mm / Chiều rộng cửa từ 500 - 900mm
 Max door height 2000mm / Door width from 500 - 900mm

THÔNG SỐ KỸ THUẬT / TECHNICAL DETAILS

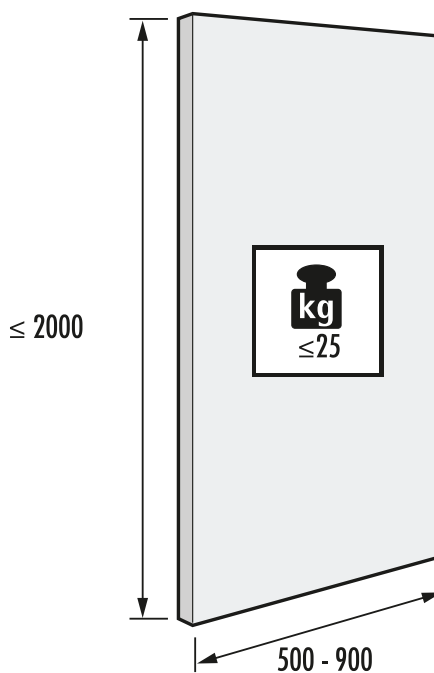

► **WINGLINE 230**



WingLine 230 is the giant among folding door systems: surface areas in excess of 6m² are swept open in a single movement. Perfect for large cabinets, e.g. in the office or utility room. As an agile room divider. Or for a walk-in cabinet in living areas that can be opened and closed with a turn of the hand. WingLine 230 has exactly what it takes, supporting doors with a door weight of 20 - 25kg. Study: side-mounting with Sensys 8645i fast assembly concealed hinge. No centre panels or bottom guide necessary.

Freedom Unlimited

Large door for utility rooms, offices, hotels, workrooms, doors for walk-in cupboards, room dividers

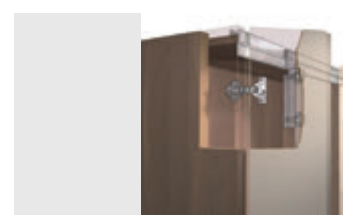
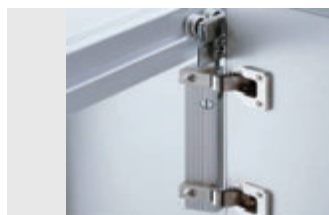
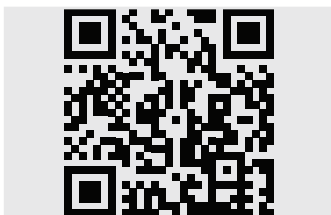

For further information please use the QR code above or the following link:
www.hettich.com/short/8af1f2

BỘ PHỤ KIỆN CỬA TRƯỢT XẾP “WINGLINE 230” CHO 4 CÁNH, CÁNH DÀY ĐẾN 22MM, KHỐI LƯỢNG 25KG/ CÁNH
FOLDING SLIDING DOOR SYSTEM WINGLINE 230 FOR 4 DOORS, DOOR THICKNESS UP TO 22MM, DOOR WEIGHT 25KGS/ DOOR



Mô Tả Description	Nhóm Group	Mã SP Cat. No	Mã Đặt Hàng Order. No	Giá bán/Bộ Price/Set
Bộ phụ kiện cửa trượt xếp WingLine 230, 4 cánh (1 bộ) Set of folding sliding system WingLine 230, 4 doors (1 set)	1	0 079 015	WL 230-100	8,000,000
Ray trượt nhôm, sơn trắng, 2400 mm (1 thanh) Runner profile, alu, white, 2400mm (1 pc)		1 079 849 (0 005 009)		

- Chiều cao cửa tối đa 3000mm / Chiều rộng cửa từ 400 - 600mm
Max door height 3000mm / Door width from 400 - 600mm
- Chưa bao gồm bản lề
Not included hinges
- Sử dụng bản lề tích hợp giảm chấn Sensys cho hiệu quả đóng êm tốt nhất (trang 9)
Use Sensys hinges with intergrated Silent system for the best soft closing effect (page 9)

THÔNG SỐ KỸ THUẬT | TECHNICAL DETAILS

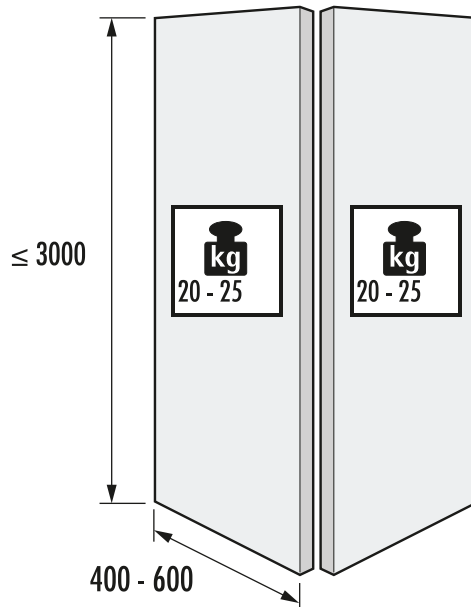

► WINGLINE L



Experiencing folding doors in a new way

WingLine L lets you produce folding sliding doors in a completely new dimension of convenience. The revolutionary Push / Pull to move opening mechanism provides access to everything inside the cabinet with just one movement of the hand. An impressive panorama effect! Further highlights: optimised running performance, soft opening and closing, tool-less installation as well as minimal door protrusion for efficiently organising the space inside. WingLine L competently and securely moves door wings weighing up to 25 kg and measuring up to 2,400 mm in height: a talented all rounder for the bedroom, kitchen and office.



For easy and gentle opening:
Push / Pull to move module first class practical convenience.



Handleless perfection:
The door set opens all the way with just one push – from the Push to move module.



Impresses everywhere:
WingLine L is suitable for all commonly used door wing formats.



Impressive running performance:
as smooth as never before and virtually silent.

BỘ PHỤ KIỆN CỬA TRƯỢT XẾP "WINGLINE L" NHẤN MỞ CHO CÁNH DÀY ĐẾN 25MM
FOLDING SLIDING DOOR SYSTEM WINGLINE L WITH PUSH TO MOVE FOR DOOR THICKNESS UP TO 25MM



CHO 4 CÁNH, KHỐI LƯỢNG 25KG/CÁNH | FOR 4 DOORS, DOOR WEIGHT 25KGS/DOOR

Mô Tả Description	Nhóm Group	Mã SP Cat. No	Mã Đặt Hàng Order. No	Giá bán/Bộ Price/Set
a/ Bộ phụ kiện cửa trượt xếp (25kg/cánh), bên trái (1bộ) Folding sliding system (25kgs/door), Left (1set)	1	9 237 880	WLPS 25 - 4	4,000,000
b/ Bộ phụ kiện cửa trượt xếp (25kg/cánh), bên phải (1bộ) Folding sliding system (25kgs/door), Right (1 set)		9 237 881		
c/ Bộ nhấn để mở - heavy, bên trái (1bộ) Push to move set - heavy, Left (1set)		9 238 052		
d/ Bộ nhấn để mở - heavy, bên phải (1bộ) Push to move set - heavy, Right (1set)		9 238 053		
e/ Bộ ray trượt trên, dẫn hướng dưới - 2400mm và bas cài (1bộ) Top Runner and bottom guide profiles - 2400mm and profile installation (1set)		9 239 310		

CHO 2 CÁNH, KHỐI LƯỢNG 25KG/CÁNH | FOR 2 DOORS, DOOR WEIGHT 25KGS/DOOR

Mô Tả Description	Nhóm Group	Mã SP Cat. No	Mã Đặt Hàng Order. No	Giá bán/Bộ Price/Set
Bộ cơ bản gồm: (a) + (c) + (e) (trang 60) (Trái) Basic set include: (a) + (c) + (e) (page 60) (Left)	1	-	WLPS 25 - 2L	2,340,000
Bộ cơ bản gồm: (b) + (d) + (e) (trang 60) (Phải) Basic set include: (b) + (d) + (e) (page 60) (Right)	1	-	WLPS 25 - 2R	2,340,000

- Chiều cao cửa tối đa 2400mm/ Chiều rộng cửa tối đa 600mm/ Độ dày cửa 16-25mm
Max door height 2400mm/ Max door width 600mm/ Door thickness 16-25mm
- Chưa bao gồm bản lề
Not included hinges
- Sử dụng với bản lề nhấn mở
Must be used with unsprung hinges

THÔNG SỐ KỸ THUẬT | TECHNICAL DETAILS

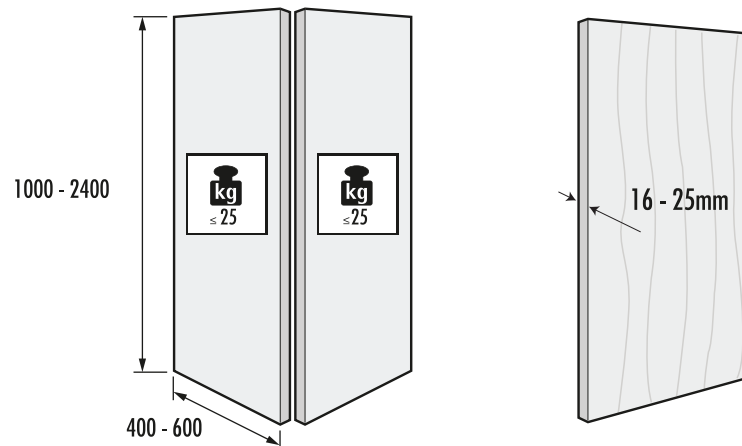

BỘ PHỤ KIỆN CỬA TRƯỢT XẾP "WINGLINE L" KÉO MỞ CHO CẢNH DÀY ĐẾN 25MM
FOLDING SLIDING DOOR SYSTEM WINGLINE L WITH PULL TO MOVE FOR DOOR THICKNESS UP TO 25MM



CHO 4 CẢNH, KHỐI LƯỢNG 25KG/CẢNH | FOR 4 DOORS, DOOR WEIGHT 25KGS/DOOR

Mô Tả Description	Nhóm Group	Mã SP Cat. No	Mã Đặt Hàng Order. No	Giá bán/Bộ Price/Set
Bộ kéo để mở - heavy, bên trái (1bộ) Pull to move set - heavy, Left (1 set)	1	9 238 125	WLPL 25-4	4,000,000
Bộ kéo để mở - heavy, bên phải (1bộ) Pull to move set - heavy, Right (1 set)		9 238 114		
Bộ cơ bản gồm: (a) + (b) + (e) (trang 60) Basic set include: (a) + (b) + (e) (page 60)		-		

CHO 2 CẢNH, KHỐI LƯỢNG 25KG/CẢNH | FOR 2 DOORS, DOOR WEIGHT 25KGS/DOOR

Mô Tả Description	Nhóm Group	Mã SP Cat. No	Mã Đặt Hàng Order. No	Giá bán/Bộ Price/Set
Bộ kéo để mở - heavy, bên trái (1bộ) Pull to move set - heavy, Left (1 set)	1	9 238 125	WLPL 25 - 2L	2,340,000
Bộ cơ bản gồm: (a) + (e) (trang 60) (Trái) Basic set include: (a) + (e) (page 60) (Left)		-		
Bộ kéo để mở - heavy, bên phải (1bộ) Pull to move set - heavy, Right (1 set)		9 238 114	WLPL 25 - 2R	2,340,000
Bộ cơ bản gồm: (b) + (e) (trang 60) (Phải) Basic set include: (b) + (e) (page 60) (Right)		-		

- Chiều cao cửa tối đa 2400mm/ Chiều rộng cửa tối đa 600mm/ Độ dày cửa 16-25mm
Max door height 2400mm/ Max door width 600mm/ Door thickness 16-25mm
- Chưa bao gồm bản lề
Not included hinges
- Sử dụng với bản lề nhấn mở
Must be used with unsprung hinges

THÔNG SỐ KỸ THUẬT | TECHNICAL DETAILS

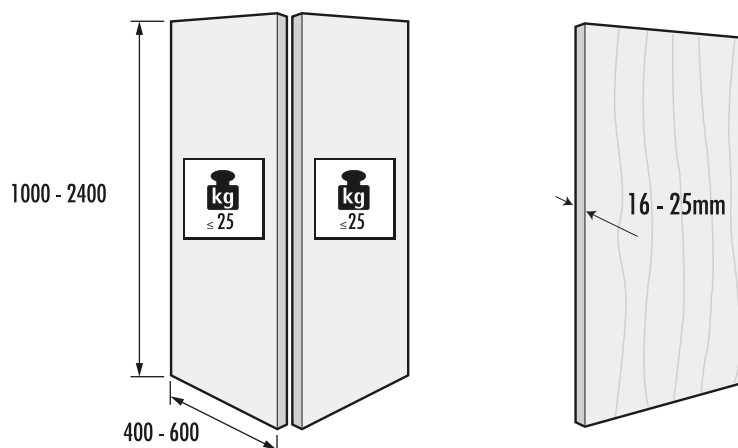

► **WINGLINE 770**



Attractive design and easy to construct: WingLine 770

3 benefits in 1 system. Are you looking for a folding door system with a high load capacity and attractive design – and do you want it to be quickly installed? If so, WingLine 770 is the perfect system for you. The door wings are quickly hooked in and aligned. The running components easily clip into the runner profile. Quality that's felt in every movement. Rated for door wing weights up to 20 kg – for plenty of design flexibility.

BỘ PHỤ KIỆN CỬA TRƯỢT XẾP “WINGLINE 770” CHO 4 CẢNH DÀY ĐẾN 19MM, KHỐI LƯỢNG 20KG/ CẢNH
FOLDING SLIDING DOOR SYSTEM WINGLINE 770 FOR 4 DOORS, DOOR THICKNESS 19MM, DOOR WEIGHT 20KGS/ DOOR



CHO 4 CẢNH CỬA | FOR 4 DOORS

Mô Tả Description	Nhóm Group	Mã SP Cat. No	Mã Đặt Hàng Order. No	Giá bán/Bộ Price/Set
a/ Bộ phụ kiện cửa trượt xếp, bên trái (1 bộ) Set of folding sliding system, left (1 set)	1	0 070 968	WL 770 - 80 B	1,400,000
b/ Bộ phụ kiện cửa trượt xếp, bên phải (1 bộ) Set of folding sliding system, right (1 set)		0 070 969		
c/ Ray trượt trên, nhôm, 2,000 mm (1 thanh) Top runner profile, alu, 2,000mm (1 bar)		1 079 089 (0 004 311)		
d/ Ray dẫn hướng dưới, nhôm, 2,000 mm (1 thanh) Bottom guide profile, alu, 2,000mm (1 bar)		0 072 919 (0 004 312)		

CHO 2 CẢNH CỬA | FOR 2 DOORS

Bộ cơ bản gồm: (a) + (c) + (d) (trang 63) (Trái) Basic set include: (a) + (c) + (d) (page 63) (Left)	1	-	WL 770 - 40 B	850,000
Bộ cơ bản gồm: (b) + (c) + (d) (trang 63) (Phải) Basic set include: (b) + (c) + (d) (page 63) (Right)	1	-	WR 770 - 40 B	850,000

- Chiều cao cửa tối đa 2,200mm | Chiều rộng cửa tối đa 500mm
Max door height 2,200mm | Max door width 500mm
- Chưa bao gồm bản lề | Not included hinges
- Sử dụng bản lề tích hợp giảm chấn Sensys cho hiệu quả đóng êm tốt nhất (trang 9)
Use Sensys hinges with intergrated Silent system for the best soft closing effect (page 9)

THÔNG SỐ KỸ THUẬT | TECHNICAL DETAILS

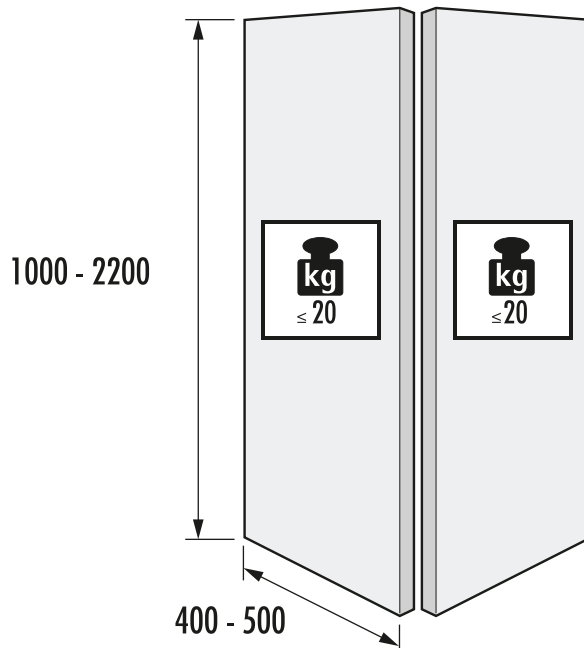

► **SLIDELINE M**



A magic space with slideline M

► **Bottom running sliding door systems**

Design upgrade for furniture. SlideLine M upgrades the practical value and design of furniture. Living room unit sand shelf systems. Kitchen wall units and bathroom furniture.

And, of course, office cabinets too. The versatile system is suitable for all common furniture constructions. Wooden, glass or aluminium framed doors weighing up

to 30 kg can be installed quickly and easily. Profiles are available for several shelf thicknesses. Sliding doors running one in front of the other in one profile are also easy to produce.

The Silent System is integrated on the running component and slows down door running action in closing, opening and colliding direction.

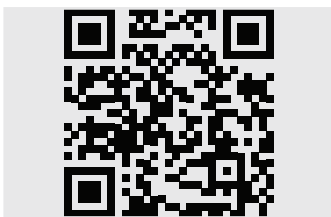

For further information please use the QR code above or the following link:
www.hettich.com/short/1a9bd5



After pulling the guide component down by means of a spring mechanism, it can be inserted and engaged in the top profile without the need for tools.



Silent System is unobtrusively integrated in slideLINE M's runner component and closes doors gently and quietly.

BỘ PHỤ KIỆN CỬA TRƯỢT SLIDE LINE M - ĐỘ DÀY CÁNH ĐẾN 19MM
SLIDING DOOR SYSTEM SLIDE LINE M - PANEL THICKNESS 19MM



Mô Tả Description	Nhóm Group	Mã SP Cat. No	Mã Đặt Hàng Order. No	Giá bán/Bộ Price/Set
Bộ phụ kiện cách trượt giảm chấn (1 bộ) Set of fittings for wooden doors with Silent System (soft closing and opening) (1 set)		9 156 338		
Bộ ray trượt 1 thanh, màu bạc, ván dày 18/19mm, dài 4000mm (1 bộ) Profile set 1 profile, silver, panel thickness 18/19mm, length 4000mm (1 set)	1	9 209 226	KD 770 - MA	4,600,000
Bộ thanh trang trí ray, chiều cao ray 18mm, màu bạc, dài 4000mm (1 bộ) Coloured set for concealing the runner profile, profile height 18mm, silver, length 4000mm (1 set)		9 209 278		

- Khối lượng cánh tối đa 30kg, Độ rộng cánh từ 450-1800 mm, Chiều cao cánh từ 300-2400mm
 Max door weight 30kg, Door width 450-1800mm, Door height 300-2400mm

THÔNG SỐ KỸ THUẬT | TECHNICAL DETAILS

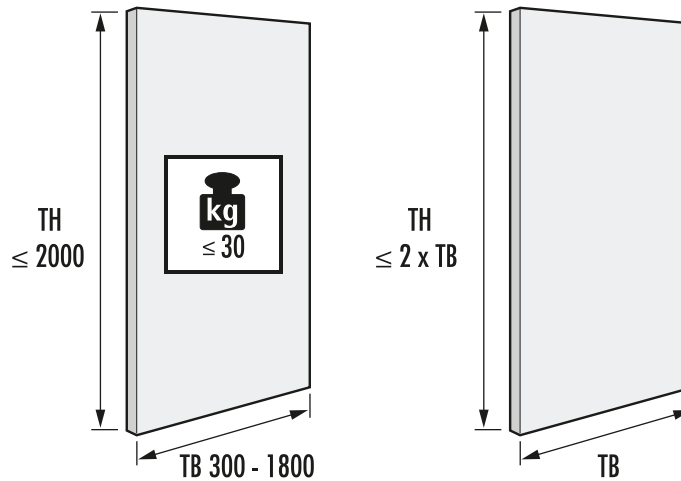

TB	300	400	500	600	700	800	900	1000	... 1800
TH ≤	600	800	1000	1200	1400	1600	1800	2000	... 2000

► SLIDELINE 55,56

BỘ PHỤ KIỆN CỬA TRƯỢT "SLIDELINE 56" LỘT LÒNG CHO 2 CÁNH DÀY ĐẾN 19MM, KHỐI LƯỢNG 40KG/ CÁNH
SLIDING DOOR SYSTEM SLIDELINE 56 FOR 2 DOORS, DOOR THICKNESS 19MM, DOOR WEIGHT 40KG/ DOOR

Mô Tả Description	Nhóm Group	Mã SP Cat. No	Mã Đặt Hàng Order. No	Giá bán/Bộ Price/Set
Bộ phụ kiện cửa trượt SlideLine 56 (1 bộ) Set of sliding door system SlideLine 56 (1 set)	1	0 045 234	SLS 056 - 40 A	950,000
Ray trượt trên và dưới, nhôm, 3,000 mm (4 thanh) Top and bottom runner profile, alu, 3,000mm (4 pcs)		0 071 110 (0 004 292)		
Bộ phụ kiện giảm chấn cho cửa trượt SlideLine 56, 2 cánh, dày 19mm (1 bộ) Silent system set for SlideLine 56, 2 doors, door thickness 19mm (1 set)	1	9 079 731	SS 056 - 40	1,020,000

- Chiều cao cửa tối đa 2,000mm / Chiều rộng cửa từ 500 - 1,000mm
Max door height 2,000mm / Door width from 500 - 1,000mm
- Tải trọng của bộ giảm chấn: 10kg/cánh
Max door weight of silent system set: 10kg/door

BỘ PHỤ KIỆN CỬA TRƯỢT "SLIDELINE 55 PLUS" CHO 2 CÁNH DÀY ĐẾN 19MM, KHỐI LƯỢNG 15KG/ CÁNH
SLIDING DOOR SYSTEM SLIDELINE 55 PLUS FOR 2 DOORS, DOOR THICKNESS 19MM, DOOR WEIGHT 15KG/ DOOR



Mô Tả Description	Nhóm Group	Mã SP Cat. No	Mã Đặt Hàng Order. No	Giá bán/Bộ Price/Set
Ray trượt trên và dưới, nhựa đen, 4,000 mm (2 thanh) Top and bottom runner profile, black plastic, 4,000mm (2 pc)	1	0 066 900	SL 055 - 15	530,000
Bộ phận dẫn hướng trên (4 cái) Top running guide components (4 pcs)		9 115 217		
Bộ phận bánh xe dưới (4 cái) Bottom runner components (4 pcs)		9 115 219		
Chặn bánh xe (4 cái) Self closing mechanism (4 pcs)		9 115 218		

- Chiều cao cửa tối đa 1,500mm / Chiều rộng cửa từ 400-800 mm
Max door height 1,500mm / Door width from 400-800 mm

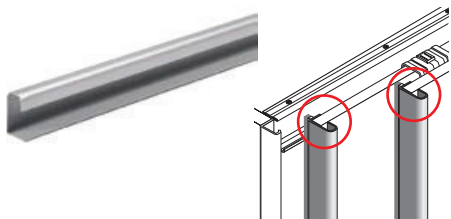
HỆ THANH NHÔM CHO CỬA TRƯỢT THẲNG, ĐỘ DÀY CÁNH 18 - 19 MM
ALUMINIUM PROFILE FOR STRAIGHT SLIDING DOOR, DOOR THICKNESS 18 - 19 MM

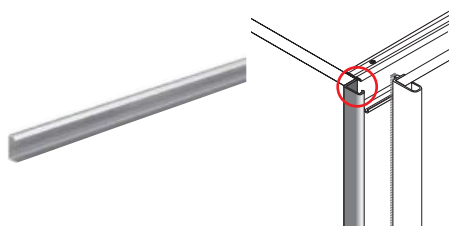
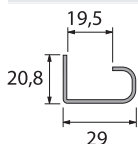

Mô Tả Description	Nhóm Group	Mã SP Cat. No	Mã Đặt Hàng Order. No	Giá bán/Thanh Price/Bar
Tay nắm nhôm cho cửa trượt, màu bạc, dài 2500mm Door profile, Aluminium, silver anodised, 2500mm	2	9 136 121 (0 004 344)	AP 019-01	180,000



Mô Tả Description	Nhóm Group	Mã SP Cat. No	Mã Đặt Hàng Order. No	Giá bán/Thanh Price/Bar
Thanh chặn tù cho cửa trong, nhôm, màu bạc, dài 2500mm Carcase end profile, rear-most door, Aluminium, silver anodised, 2500mm	2	9 146 622 (0 004 346)	AP 019-02	100,000

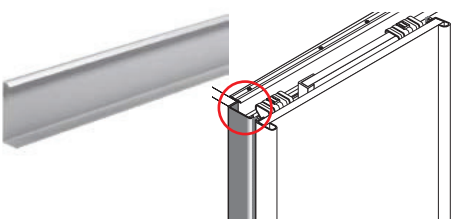
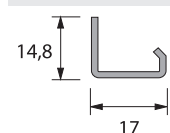

Mô Tả Description	Nhóm Group	Mã SP Cat. No	Mã Đặt Hàng Order. No	Giá bán/Thanh Price/Bar
Thanh chặn tù cho cửa ngoài, nhôm, màu bạc, dài 2500mm Carcase end profile, front-most door, Aluminium, silver anodised, 2500mm	2	9 146 624 (0 004 345)	AP 019-03	200,000

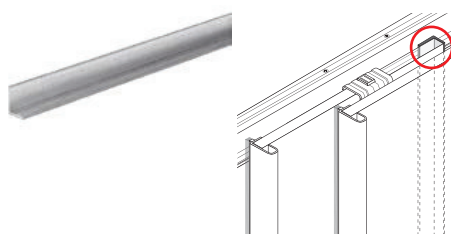
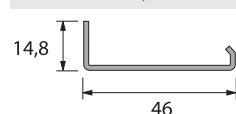

Mô Tả Description	Nhóm Group	Mã SP Cat. No	Mã Đặt Hàng Order. No	Giá bán/Thanh Price/Bar
Thanh chặn chữ L cho cửa trong, nhôm, màu bạc, dài 2500mm Door profile, L-shape, rear most door, aluminium, silver anodised, 2500mm	2	0 004 343	AP 019-04	125,000

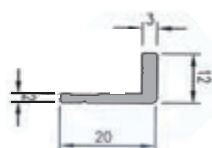

ROONG CHẮN BỤI CHO CỬA TRƯỢT THẲNG, ĐỘ DÀY CÁNH 18-19MM
BRUSHING SEALING STRIP FOR STRAIGHT SLIDING DOOR, DOOR THICKNESS 18 - 19 MM

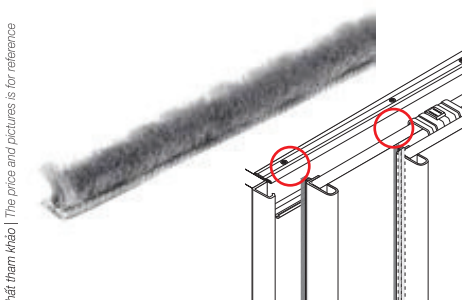

Mô Tả Description	Nhóm Group	Mã SP Cat. No	Mã Đặt Hàng Order. No	Giá bán/Cái Price/Pc
Roong chắn bụi, tự dính, dài 2500mm Brush sealing strip, self-adhesive, 2500 mm	2	9 129 901	BS 025-01	125,000

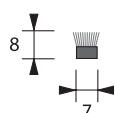

Giá và hình ảnh mang tính chất tham khảo | The price and pictures is for reference

Bảng giá chưa bao gồm thuế VAT 10% và phí vận chuyển
 The prices are not include 10% VAT and transportation fee



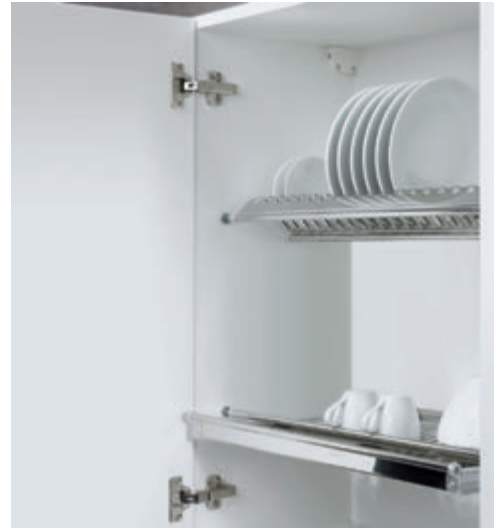
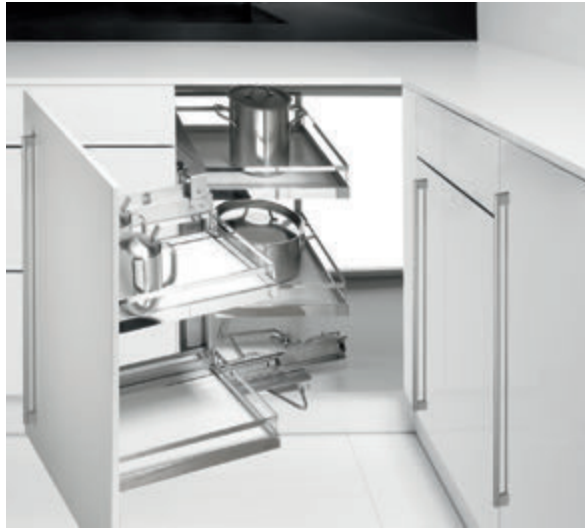

PHỤ KIỆN



ACCESSORIES

PHỤ KIỆN TỦ QUẦN ÁO
WARDROBE ACCESSORIES

Mô Tả Description	Nhóm Group	Mã SP Cat. No	Mã Đặt Hàng Order. No	Giá bán/Cái Price/Pc
Giá treo quần, R551-600 x S500 Pull-out trouser holder, W551-600 x D500	2	9 079 960	WS 600 - T	2,340,000



Mô Tả Description	Nhóm Group	Mã SP Cat. No	Mã Đặt Hàng Order. No	Giá bán/Cái Price/Pc
Giá treo quần, R935-1000 x S500 Pull-out trouser holder, W935-1000 x D500	2	9 079 963	WS 100 - T	3,650,000



Mô Tả Description	Nhóm Group	Mã SP Cat. No	Mã Đặt Hàng Order. No	Giá bán/Cái Price/Pc
Thanh Treo cavat gắn vách, R455 x D74 x H87 Telescopic tie rack, W455 x D74 x H87	2	0 070 659	WS 455 - C	1,760,000

GIÁ ỦP CHÉN ĐĨA
KITCHEN SUPPORT

Mô Tả Description	Nhóm Group	Mã SP Cat. No	Mã Đặt Hàng Order. No	Giá bán/Bộ Price/Set
Giá úp chén R560 x S224 Drainer system W560 X D224	2	9 079 810	BS 600 - W	2,400,000
Giá úp chén R760 x S224 Drainer system W760 X D224		9 079 811	BS 800 - W	2,850,000
Giá úp chén R860 x S224 Drainer system W860 X D224		9 079 812	BS 900 - W	3,120,000

THÙNG RÁC
WASTE BIN



Mô Tả Description	Nhóm Group	Mã SP Cat. No	Mã Đặt Hàng Order. No	Giá bán/Cái Price/Pc
Thùng rác 13 lít, R340 x S270 x C350 Waste Bin 13 liters, W340 x D270 x H350 mm	2	9 079 970	RR 970 - I	1,270,000

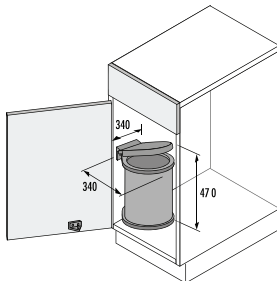

THÙNG RÁC DUO II
BIN. IT DUO II



Mô Tả Description	Nhóm Group	Mã SP Cat. No	Mã Đặt Hàng Order. No	Giá bán/Cái Price/Pc
Bộ thùng rác nhựa 20L x 2, màu xám Set of bins 20 ltr x 2, grey color, W338 x D485 x H385	2	0 049 474	RR 474-P	4,650,000

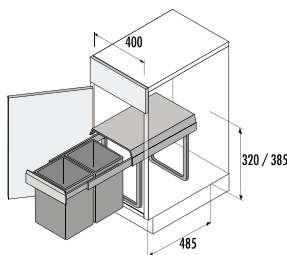

BỘ PHỤ KIỆN CHỐNG CONG CÁNH CỬA
STRAIGHTEN DOOR FITTINGS



Mô Tả Description	Nhóm Group	Mã SP Cat. No	Mã Đặt Hàng Order. No	Giá bán/Bộ Price/Set
Bộ phụ kiện chống cong cánh cửa Straighten doors fittings	2	0 073 347	SD 026 - M	310,000

- Chiều cao cửa tối đa: 2600 mm
Max. door height: 2600 mm
- Chiều dày cửa tối thiểu: 16mm
Min. door thickness: 16mm

Giá và hình ảnh mang tính chất tham khảo | The price and pictures is for reference

Bảng giá chưa bao gồm thuế VAT 10% và phí vận chuyển
The prices are not include 10% VAT and transportation fee

CHÂN TỨ CAO 100MM
HEIGHT-ADJUSTABLE LEG 100MM

Mô Tả Description	Nhóm Group	Mã SP Cat. No	Mã Đặt Hàng Order. No	Giá bán/Bộ Price/Set
Chân tủ bếp 100mm (điều chỉnh từ 89-125mm) Height-adjustable leg 100mm (adjustable 89 - 125mm)	2	0 061 851	KL 100 - B	23,500
Đế cố định chân tủ bếp, loại bắt vít Fixing block "Universal", screw on type		0 061 854		
Bas kẹp chân bếp, loại bắt vít, dùng cho len chân bếp gỗ Plinth clip, screw on type, use for wood bar kitchen skirting	2	0 061 855	KL 100 - K	4,500
Bas kẹp chân bếp, loại gài, dùng cho len chân bếp nhôm Plinth clip, click on type, use for aluminium bar kitchen skirting	2	-	KL 100 - A (KL 100 - H)	4,500

LEN CHÂN BẾP
KITCHEN SKIRTING

Mô Tả Description	Nhóm Group	Mã SP Cat. No	Mã Đặt Hàng Order. No	Giá bán/Thanh Price/Bar
Thanh nhôm len chân bếp dài 3000mm Kitchen aluminium bar skirting - 3000mm	2	0 004 369	LB 100 - 03	430,000
Thanh nhôm len chân bếp dài 6000mm Kitchen aluminium bar skirting - 6000mm	2	0 024 369	LB 100 - 06	860,000

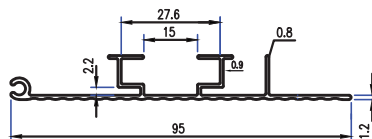
PHỤ KIỆN TREO TỦ BẾP
CABINET SUSPENSION BRACKETS

Mô Tả Description	Nhóm Group	Mã SP Cat. No	Mã Đặt Hàng Order. No	Giá bán/Cái Price/Pc
Móc treo có thể điều chỉnh, tải trọng 65kg/cái Loading capacity 65kg/pc	2	0 045 062 (9 208 645 + 9 208 646)	HC 065 - I	65,000
Trái phải dùng chung (1 cái) same for left and right (1 pc)				
Móc treo âm có thể điều chỉnh, tải trọng 110kg/cặp Loading capacity 110kg/pr	2	0 079 717	HC 055 - B	101,000
(1 cặp) (1 pr)				
Bas cho phụ kiện treo Suspension rail	2	1 012 777	HB 099 - A1	8,900
Trái phải dùng chung (1 cái) same for left and right (1 pc)				
Bas cho phụ kiện treo Suspension rail	2	9 208 678	HB 099 - A2	8,900

KHAY CHIA ORGA CHO RAY HỘP “INNOTECH”
INNOTECH ORGATRAY



Mô Tả Description	Nhóm Group	Mã SP Cat. No	Mã Đặt Hàng Order. No	Giá bán/Cái Price/Pc
Khay chia OrgaTray 410, R801-850xS441-520mm, màu trắng Innotech OrgaTray 410, W801-850xS441-520mm, white colour	2	9 113 830	0T 900 - W1	750,000
Khay chia OrgaTray 410, R801-850xS441-520mm, màu bạc Innotech OrgaTray 410, W801-850xS441-520mm, silver colour		0 044 945	0T 900 - S1	750,000



- Chưa bao gồm: Dụng cụ để dao và chai lọ
Not included: Knife holder and spice rack/flat, lying flat



Mô Tả Description	Nhóm Group	Mã SP Cat. No	Mã Đặt Hàng Order. No	Giá bán/Cái Price/Pc
Khay chia OrgaTray 430, R312 x S462mm, màu bạc Innotech OrgaTray 430, W312xD470mm, silver color	2	9 079 172	0T 400-S1	230,000
Khay chia OrgaTray 430, R412x S462mm, màu bạc Innotech OrgaTray430, W412xD470mm, silver color		9 079 173	0T 500-S4	320,000

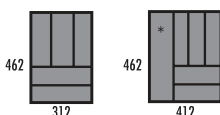

- Chưa bao gồm: Dụng cụ để dao và chai lọ
Not included: Knife holder and spice rack/flat, lying flat



Mô Tả Description	Nhóm Group	Mã SP Cat. No	Mã Đặt Hàng Order. No	Giá bán/Cái Price/Pc
Khay chia OrgaTray 560, R415 x S462mm, màu trắng Innotech OrgaTray 560, W415xD470mm, white color	2	9 113 861	0T 500 - W3	550,000
Khay chia OrgaTray 560, R815 x S462mm, màu bạc Innotech OrgaTray 560, W815xD462mm, silver color		0 013 308	0T 900 - S2	1,200,000

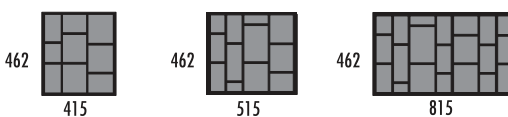

- Bao gồm: Thanh chia hộp
Included: Diving elements, length 78mm (10 pcs)
Diving elements, length 128mm (4 pcs)

KHAY CHIA ORGASTORE CHO RAY HỘP “INNOTECH”
INNOTECH ORGASTORE



Mô Tả Description	Nhóm Group	Mã SP Cat. No	Mã Đặt Hàng Order. No	Giá bán/Bộ Price/Set
Khay chia OrgaStore 100/500, chiều rộng hộc 500mm, 5 vách chia, màu bạc OrgaStore 100/500 - carcass width 500mm - 5 dividers, silver color	2	9 005 267	0S 500-G	750,000
Khay chia OrgaStore 100/800, chiều rộng hộc 800mm, 8 vách chia, màu bạc OrgaStore 100/800 - carcass width 800mm - 8 dividers, silver color	2	9 005 269	0S 800-G	1,150,000

Giá và hình ảnh mang tính chất tham khảo. | The price and pictures is for reference

Bảng giá chưa bao gồm thuế VAT 10% và phí vận chuyển
The prices are not include 10% VAT and transportation fee

KHAY CHIA GỖ CHO NGĂN KÉO
WOODEN TRAY FOR DRAWER

Mô Tả Description	Nhóm Group	Mã SP Cat. No	Mã Đặt Hàng Order. No	Giá bán/Cái Price/Pc
Khay chia gỗ cho ngăn kéo, R520 x S460 x C70 mm Wooden tray for drawer, W520 x D460 x H70 mm	2	-	WT 600 - P	520,000

- Sử dụng phù hợp với các loại ray âm Quadro, dài 500mm
Can use with all Quadro runner, length 500mm



Mô Tả Description	Nhóm Group	Mã SP Cat. No	Mã Đặt Hàng Order. No	Giá bán/Cái Price/Pc
Khay chia gỗ cho ngăn kéo, R820 x S460 x C70 mm Wooden tray for drawer, W820 x D460 x H70 mm	2	-	WT 900 - P	760,000

- Sử dụng phù hợp với các loại ray âm Quadro, dài 500mm
Can use with all Quadro runner, length 500mm

NGĂN KÉO ÂM BẰNG GỖ, MẶT TRƯỚC KÍNH CHO TỦ RỘNG 600MM
WOODEN INNER DRAWER, GLASS FRONT FOR 600MM CABINET



Mô Tả Description	Nhóm Group	Mã SP Cat. No	Mã Đặt Hàng Order. No	Giá bán/Bộ Price/Set
Ngăn kéo âm bằng gỗ, R548 x S500 x C110 mm, gỗ dày 12mm Wooden tray for drawer, W548 x D500 x H110 mm, panel thickness 12mm	2	-	SH 110 - G	640,000
Ngăn kéo âm bằng gỗ, R548 x S500 x C150 mm, gỗ dày 12mm Wooden tray for drawer, W548 x D500 x H150 mm, panel thickness 12mm		-	SH 150 - G	680,000
Ngăn kéo âm bằng gỗ, R548 x S500 x C200 mm, gỗ dày 12mm Wooden tray for drawer, W548 x D500 x H200 mm, panel thickness 12mm		-	SH 200 - G	760,000

- Chiều rộng hộc tủ: Tủ bì 600mm, lọt lòng 562-564mm
Width of cabinet: Outer width 600mm, inner width 562-564mm
- Sử dụng phù hợp với các loại ray âm Quadro dài 500mm
Can be used with all Quadro runner, length 500mm
- Bao gồm kiếng mờ, không dấu vân tay
With tempered glass, no finger-print
- Chưa bao gồm ray trượt
Not included runners

KỆ ĐỒ KHÔ BẰNG GỖ
WOODEN PULL-OUT SHELF UNIT



Mô Tả Description	Nhóm Group	Mã SP Cat. No	Mã Đặt Hàng Order. No	Giá bán/Bộ Price/Set
Kệ đồ khô bằng gỗ Birch Kích thước: C2300 x R450 x S500mm Wooden pull-out shelf unit Dimension: H2300 x W450 x D500mm	2	-	SH 005 - WB	4,000,000

KỆ ĐỒ KHÔ CÁNH MỞ 6 TẦNG TANDEM
PULL-OUT SHELF UNIT TANDEM - 6 SHELVES

Mô Tả Description	Nhóm Group	Mã SP Cat. No	Mã Đặt Hàng Order. No	Giá bán/Bộ Price/Set
Khung cho kệ đồ khô 6 tầng, R412-418 x C1700 mm (1 cái) Pull-out frame W412-418mm X H1700mm (1 pc)	2	0 070 820 (9 083 798)	SH 005 - D	34,000,000
Bộ phận rổ gắn trên cánh 1700mm (1 cái) Door self unit 1700mm (1 pc)		9 079 864		
Rổ đựng Arena (6 cái) Arena style basket (6 pcs)		9 080 150		

- Bộ khay Arena style màu trắng sáng, thành khung mạ crom bóng, đáy khay sơn trắng có lớp chống trượt
All components in brilliant white, tray Arena style, gallery bright chrome, bottom "Ice White" with AntiSlip

KỆ ĐỒ KHÔ CÁNH KÉO DISPENSA 90°
PANTRY UNIT DISPENSA 90°

Mô Tả Description	Nhóm Group	Mã SP Cat. No	Mã Đặt Hàng Order. No	Giá bán/Bộ Price/Set
Khung cho kệ đồ khô 5 tầng Dispensa 90°, R362 X C1900-2300 mm (1 bộ) Aluminium Pull-out frame for Dispensa 90°, W362 X H1900-2300 mm (1 set)	2	9 117 214	SH 005 - S	21,300,000
Bộ phận ray trượt (1 bộ) Full extension runner (1 set)		9 117 223		
Bas nối trước cho khung rổ (2 cái) Stabiliser for frame fronts (2 pcs)		0 070 799		
Bộ phận ổn định (1 cái) Dispensa front stabiliser (1 pc)		0 070 800		
Ống nối đỡ rổ, điều chỉnh chiều cao, 125mm (2 cặp) Basket support Dispensa, 125mm (2 pairs)		0 074 848		
Rổ đựng Arena (5 cái) Arena style basket (5 pcs)		9 080 089		

- Bộ khay Arena style màu trắng sáng, thành khung mạ crom bóng, đáy khay sơn trắng có lớp chống trượt
All components in brilliant white, tray Arena style, gallery bright chrome, bottom "Ice White" with AntiSlip

PHỤ KIỆN CHO TỦ BẾP BÊN DƯỚI 150MM
BASE UNIT PULL-OUT 150MM



Mô Tả Description	Nhóm Group	Mã SP Cat. No	Mã Đặt Hàng Order. No	Giá bán/Bộ Price/Set
Rổ đựng gia vị 2 tầng cho ngăn tủ rộng 150mm, màu bạc, tải trọng 15kg (1 bộ) Front pull-out Cargo IQ Plus 150, 2 tier, silver colour, load capacity 15kg (1 set)	2	9 077 588	CI150-15	2,610,000
Mặt đáy khay rổ 150mm, nhựa trong mờ (2 cái) Adjustable shelf, translucent plastic (2 pcs)		9 077 601		
Ray âm dài 470mm, giảm chấn, ván thùng tủ dày 18mm, trái/ phải (1 cặp) Drawer runner 470mm, Silent system, panel thickness 18mm, left/ right (1 pr)		9 118 054 9 118 055		

PHỤ KIỆN CHO TỦ BẾP BÊN DƯỚI 200 MM
BASE UNIT PULL-OUT 200MM



Mô Tả Description	Nhóm Group	Mã SP Cat. No	Mã Đặt Hàng Order. No	Giá bán/Bộ Price/Set
Rổ đựng gia vị 2 tầng cho ngăn tủ rộng 200mm, màu bạc, tải trọng 17,5kg (1 bộ) Front pull-out Cargo IQ Plus 200, 2 tier, silver color, load capacity 17,5kg (1 set)	2	9 065 857	CI200-17	2,700,000
Mặt đáy khay rổ 200mm, nhựa trong mờ (2 cái) Adjustment shelf, translucent plastic (2 pcs)		9 065 861		
Ray âm dài 470mm, giảm chấn, ván thùng tủ dày 18mm, trái/phải (1 cặp) Drawer runner 470mm with silent systems, panel thickness 18mm, left/right (1 pair)		9 118 054 9 118 055		

PHỤ KIỆN CHO TỦ BẾP BÊN DƯỚI 300MM
BASE UNIT PULL-OUT 300MM



Mô Tả Description	Nhóm Group	Mã SP Cat. No	Mã Đặt Hàng Order. No	Giá bán/Bộ Price/Set
Rổ đựng gia vị 2 tầng cho ngăn tủ rộng 300mm, màu bạc, tải trọng 20kg (1 bộ) Front pull-out Cargo IQ Plus 300, 2 tier, silver colour, load capacity 20kg (1 set)	2	9 065 860	CI 300-20	2,900,000
Mặt đáy khay rổ 300mm, nhựa trong mờ (2 cái) Adjustable shelf, translucent plastic (2 pcs)		9 065 862		
Ray âm dài 470mm, giảm chấn, ván thùng tủ dày 18mm, trái và phải (1 cặp) Drawer runner 470mm, Silent system, panel thickness 18mm, left and right (1 pr)		9 118 054 9 118 055		

Giá và hình ảnh mang tính chất tham khảo | The price and pictures is for reference

Bảng giá chưa bao gồm thuế VAT 10% và phí vận chuyển
 The prices are not include 10% VAT and transportation fee

KỆ GÓC TỦ BẾP MOVING-CORNER
CORNER UNIT PIVOTING PULL-OUT MOVING-CORNER

Mô Tả Description	Nhóm Group	Mã SP Cat. No	Mã Đặt Hàng Order. No	Giá bán/Bộ Price/Set
Kệ góc tủ bếp, giảm chấn, mở trái Moving corner, soft closing, swivel left	2	0 073 504 (9 083 442)	C0 504-L	19,750,000
Kệ góc kiểu Arena chống trượt (2+2 kệ) Arena style non-slip clip on shelves (2+2 shelves)		9 080 011		

• Bộ khay Arena style màu trắng sáng, thành khung mạ crom bóng, đáy khay sơn trắng có lớp chống trượt
 All components in brilliant white, tray Arena style, gallery bright chrome, bottom "Ice White" with AntiSlip Coating



Mô Tả Description	Nhóm Group	Mã SP Cat. No	Mã Đặt Hàng Order. No	Giá bán/Bộ Price/Set
Kệ góc tủ bếp, giảm chấn, mở phải Moving corner, soft closing, swivel right	2	0 073 505 (9 083 438)	C0 504-R	19,750,000
Kệ góc kiểu Arena chống trượt (2+2 kệ) Arena style non-slip clip on shelves (2+2 shelves)		9 080 011		

• Bộ khay Arena style màu trắng sáng, thành khung mạ crom bóng, đáy khay sơn trắng có lớp chống trượt
 All components in brilliant white, tray Arena style, gallery bright chrome, bottom "Ice White" with AntiSlip Coating

KỆ GÓC LEMANS II
LEMANS II CONER UNIT SWIVEL PULL-OUT

Mô Tả Description	Nhóm Group	Mã SP Cat. No	Mã Đặt Hàng Order. No	Giá bán/Bộ Price/Set
Bộ khay xoay kiểu Arena, trái trọng 25 kg/mâm - trái (1 bộ) Shelf sets, Arena style, Left (1 set)	2	9 136 151	LMII -2L	12,900,000
Trục quay cho Leman II, 600-750, màu trắng (1 thanh) Pivot arms for LeMans II, 600 - 750, White		9 132 546		
Giảm chấn cho Lemans II, trái (1 bộ) Silent System for LeMans II, left		9 132 399		



Mô Tả Description	Nhóm Group	Mã SP Cat. No	Mã Đặt Hàng Order. No	Giá bán/Bộ Price/Set
Bộ khay xoay kiểu Arena, trái trọng 25 kg/mâm - phải (1 bộ) Shelf sets, Arena style, right (1 set)	2	9 136 152	LMII -2R	12,900,000
Trục quay cho Leman II, 600-750, màu trắng (1 thanh) Pivot arms for LeMans II, 600 - 750, White		9 132 546		
Giảm chấn cho Lemans II, phải (1 bộ) Silent System for LeMans II, left		9 132 400		

KỆ GÓC REVO 90 REVO 90 CONER UNIT CAROUSEL FITTING



Mô Tả Description	Nhóm Group	Mã SP Cat. No	Mã Đặt Hàng Order. No	Giá bán/Bộ Price/Set
Bộ phụ kiện kệ góc Revo 90 for shelf 900x900mm (1 bộ) Set of Revo 90 - 900x900mm (1 set)	2	9 080 040	RV90 -02	11,150,000
Kệ Arena cho Revo 90 , size 900x900mm(2 cái) Arena STYLE non-slip shelf, 900 x 900mm (2 pcs)		9 080 043		
Tủ cao lọt lòng : 660 - 860mm Inside height : 660-860mm		Tải trọng cho mỗi khay <= 25kg Loading capacity per shelf <= 25kg		

KỆ GÓC 3/4 THREE - QUARTER CIRCLE CAROUSEL FITTING



Mô Tả Description	Nhóm Group	Mã SP Cat. No	Mã Đặt Hàng Order. No	Giá bán/Bộ Price/Set
Bộ phụ kiện kệ góc 3/4, kiểu khay Arena 700m, mạ chrome bóng Arena STYLE three-quarter circle carousel tray 700 mm, chrome plated	2	9 079 941	CC02- 3/4	8,150,000

BỘ NHẤN MỞ TỰ ĐỘNG BẰNG ĐIỆN "EASYS"
EASYS ELECTROMECHANICAL OPENING SYSTEM

Mô Tả Description	Nhóm Group	Mã SP Cat. No	Mã Đặt Hàng Order. No	Giá bán/Bộ Price/Set
Giá đỡ có dây dài 800mm (1 cái) Easy mounting set (1 pc)	2	9 082 357	AU 001 - E	18,100,000
Thanh nhôm liên kết 1m (1 cái) Easy profile set - 1000mm (1 pc)		9 082 356		
Bas đẩy hộc tủ - 3 ngăn kéo (3 cái) Easy B automatic drive - 3 drawers (3 pcs)		9 078 139		
Dây nguồn 2m (1 cái) Easy extension lead 2M (1 pc)		9 100 852		
Bộ biến thế (1 cái) Easy distribution block (1 pc)		9 082 360		
Bas đỡ bộ biến thế (1 cái) Distribution block holder (1 pc)		9 097 923		
Dây cho bộ biến thế 2,5m (1 cái) Extension distributor 2500mm (1 pc)		9 106 449		
Nguồn cho bộ biến thế (1 cái) Power supp JIG (1 pc)		9 082 363		
Dây nguồn 1,8m (1 cái) Zuleitung euroflachstecker 1800mm (1 pc)		9 079 710		
Bas đỡ bộ nguồn cho biến thế (1 cái) Power supply unit holder (1 pc)		9 082 364		
Bas đỡ phía sau Ray Innotech 12mm (1 cái) BP-bracket int. drawer/P&P drawer (1 pc)		9 086 714		
Bas đỡ phía sau Ray Innotech 16mm (1 cái) BP-bracket Alu (1 pc)		9 097 922		
Nút nhấn mở tủ (10 cái) BP-bracket Alu (10 pcs)		9 082 365		

CHỐT ĐỠ KỆ
DECORATIVE SHELF SUPPORT

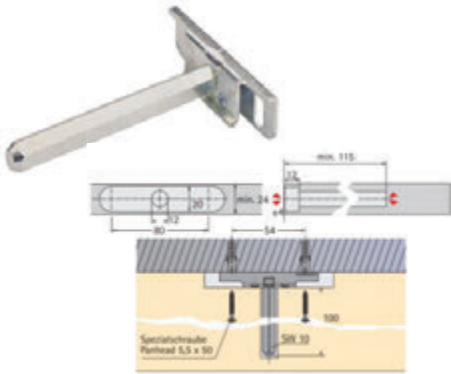

Mô Tả Description	Nhóm Group	Mã SP Cat. No	Mã Đặt Hàng Order. No	Giá bán/Cái Price/Pc
Chốt âm đỡ kệ trang trí Decorative shelf support	2	0 047 661	SS 661 - S	32,000

- Kích thước kệ tối đa 1,000 X 300 mm, tải trọng 50kg/m²
Max. shelf dimension 1,000 X 300 mm, load: 50kgs/m²
- Điều chỉnh độ cao: ± 4 mm
Height adjustment: ± 4 mm
- Độ dày gỗ tối thiểu: 24 mm
Minimum shelf thickness: 24 mm

ỐC LIÊN KẾT RASTEX 15
CONNECTING FITTINGS RASTEX 15

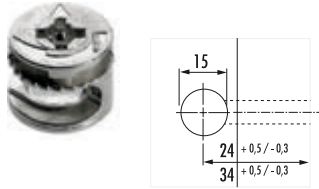

Mô Tả Description	Nhóm Group	Mã SP Cat. No	Mã Đặt Hàng Order. No	Giá bán/Cái Price/Pc
Đầu ốc liên kết cho ván dày 12mm, mạ Nickel Cam fittings Rastex for panel thickness 12mm, nickel plated	2	9 116 018	RT 015 - 12	910
Đầu ốc liên kết cho ván dày 15mm, mạ Nickel Cam fittings Rastex for panel thickness 15mm, nickel plated		9 064 684	RT 015 - 15	1,000
Đầu ốc liên kết cho ván dày 18mm, mạ Nickel Cam fittings Rastex for panel thickness 18mm, nickel plated		9 056 601	RT 015 - 18	1,050

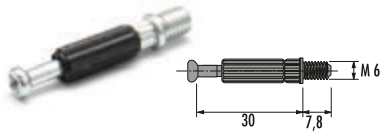

Mô Tả Description	Nhóm Group	Mã SP Cat. No	Mã Đặt Hàng Order. No	Giá bán/Cái Price/Pc
Thân ốc liên kết, đường ren M6 x 7,8mm, dài 30mm Twister Screw-in dowel 30mm, thread M6 x 7.8 mm	2	9 047 865	TS 030 - M6	780

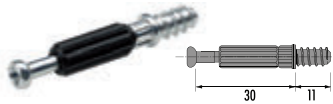

Thân ốc liên kết, đường ren vít châu Âu Ø 5mm, dài 30mm Twister Screw-in dowel 30mm, Euro screw thread for Ø 5 mm hole	2	9 047 861	TS 030 - E5	780
---	---	-----------	-------------	-----

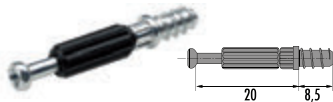

Thân ốc liên kết, đường ren vít châu Âu Ø 5mm, dài 20mm Twister Screw-in dowel 20mm, Euro screw thread for Ø 5 mm hole	2	9 047 975	TS020 - E5	780
---	---	-----------	------------	-----

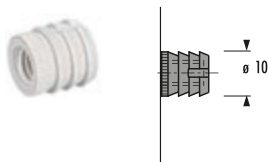

Mô Tả Description	Nhóm Group	Mã SP Cat. No	Mã Đặt Hàng Order. No	Giá bán/Cái Price/Pc
Tắc kê nhựa cho thân ốc M6, lỗ khoan Ø 10 mm, nhựa trắng Socket for thread M6, for Ø 10 mm hole, white plastic	2	1 004 928	SP 010 - M6	390
Tắc kê nhựa cho thân ốc ren châu Âu, lỗ khoan Ø 10 mm, nhựa trắng Socket with Euro screw thread, for ø 10 mm hole, white plastic		9 038 031	SP 010 - E5	350



Mô Tả Description	Nhóm Group	Mã SP Cat. No	Mã Đặt Hàng Order. No	Giá bán/Cái Price/Pc
Nắp che ốc liên kết Rastex 15, màu trắng Cover caps for Rastex 15, white	2	-	CC 015 - W	120
Nắp che ốc liên kết Rastex 15, màu đen Cover caps for Rastex 15, black		-	CC 015 - B	120
Nắp che ốc liên kết Rastex 15, màu gỗ thông Cover caps for Rastex 15, pine		-	CC 015 - P	120

Các màu đặc biệt, vui lòng liên hệ để đặt hàng (tối thiểu 10,000 cái)
For special colours, please contact us for order separate (MOQ 10,000 pcs)





TAY NẮM



DECORATIVE FURNITURE HANDLES



TAY NẮM ÂM DẠNG TRÒN
ROUND TOUCH - IN HANDLE



Mô Tả Description	Nhóm Group	Mã SP Cat. No	Mã Đặt Hàng Order. No	Giá bán/Cái Price/Pc
Tay nắm Touch-in Chrome, đường kính 92mm khoảng cách bắt vít 84mm	2	9 086 690	HR 690 - C	550,000
Touch-in Chrome Handles, diameter 92mm hole spacing 84mm				
Tay nắm Touch-in Inox, đường kính 92mm khoảng cách bắt vít 84mm	2	9 086 689	HR 690 - I	715,000
Touch-in Inox Handles, diameter 92mm hole spacing 84mm				

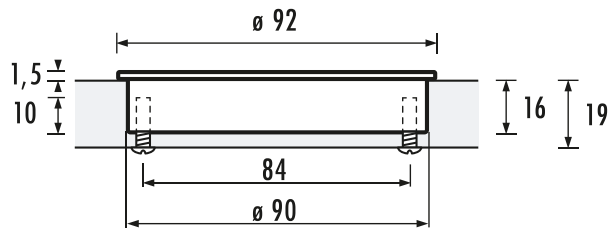

TAY NẮM ÂM DẠNG TRÒN
ROUND TOUCH - IN HANDLE



Mô Tả Description	Nhóm Group	Mã SP Cat. No	Mã Đặt Hàng Order. No	Giá bán/Cái Price/Pc
Tay nắm Touch-in Chrome, đường kính 92mm khoảng cách bắt vít 84mm	2	9 086 694	HR 694 - C	370,000
Touch-in Chrome Handles, diameter 92mm hole spacing 84mm				
Tay nắm Touch-in Inox, đường kính 92mm khoảng cách bắt vít 84mm	2	9 086 693	HR 693 - I	370,000
Touch-in Inox Handles, diameter 92mm hole spacing 84mm				

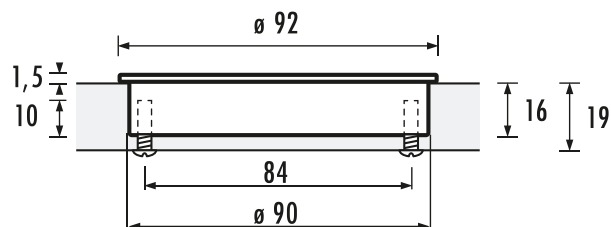



TAY NẮM ÂM DẠNG HÌNH CHỮ NHẬT
RECTANGULAR TOUCH - IN HANDLE



Mô Tả Description	Nhóm Group	Mã SP Cat. No	Mã Đặt Hàng Order. No	Giá bán/Cái Price/Pc
Tay nắm Touch-in Chrome, dài 181mm, cao 46mm, khoảng cách bắt vít 172mm	2	9 086 688	HL 181 - C	595,000
Touch-in Chrome Handles, width 92mm, height 46mm, hole spacing 172mm				
Tay nắm Touch-in Inox, dài 181mm, cao 46mm, khoảng cách bắt vít 172mm	2	9 086 687	HL 181 - I	910,000
Touch-in Inox Handles, width 92mm, height 46mm, hole spacing 172mm				

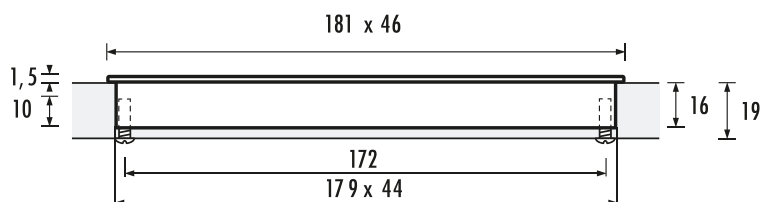

TAY NẮM ÂM DẠNG HÌNH CHỮ NHẬT
RECTANGULAR TOUCH - IN HANDLE



Mô Tả Description	Nhóm Group	Mã SP Cat. No	Mã Đặt Hàng Order. No	Giá bán/Cái Price/Pc
Tay nắm Touch-in Chrome, dài 181mm, cao 46mm, khoảng cách bắt vít 172mm	2	9 086 692	HL 692 - C	450,000
Touch-in Chrome Handles, width 92mm, height 46mm, hole spacing 172mm				
Tay nắm Touch-in Inox, dài 181mm, cao 46mm, khoảng cách bắt vít 172mm	2	9 086 691	HL 691 - I	450,000
Touch-in Inox Handles, width 92mm, height 46mm, hole spacing 172mm				

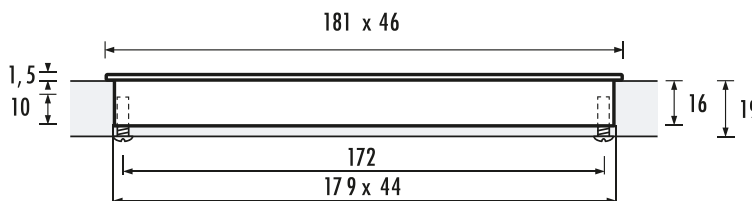

Giá và hình ảnh mang tính chất tham khảo | The price and pictures is for reference

Bảng giá chưa bao gồm thuế VAT 10% và phí vận chuyển
The prices are not include 10% VAT and transportation fee

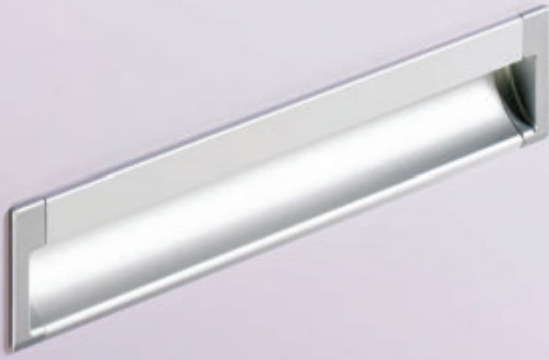

TAY NẮM ESLINGA
ESLINGA HANDLE



Mô Tả Description	Nhóm Group	Mã SP Cat. No	Mã Đặt Hàng Order. No	Giá bán/Cái Price/Pc
Tay nắm nhôm Eslinga 2000mm Eslinga Alu Handles 2000mm	2	0 115 090	HL 200 - P	930,000

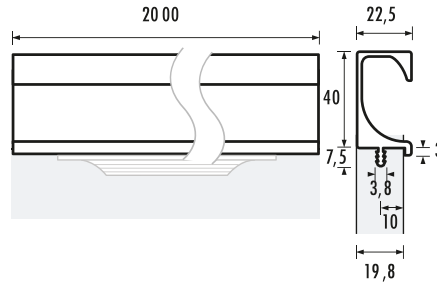

TAY NẮM SPRIA
SPRIA HANDLE



Mô Tả Description	Nhóm Group	Mã SP Cat. No	Mã Đặt Hàng Order. No	Giá bán/Cái Price/Pc
Tay nắm nhôm Spria 2000mm Spria Alu Handles 2000mm, Anodised aluminium	2	0 115 314	HL 200 - S	695,000
Nắp che tay nắm nhôm Spria (1 cặp) End piece Spira (1 pair)	2	0 115 298	HL 200 - SE	120,000

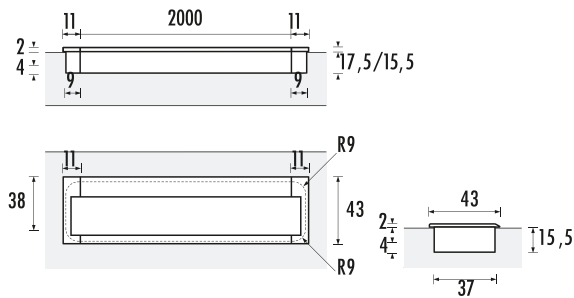



TAY NẮM NUBIA
NUBIA HANDLE



Mô Tả Description	Nhóm Group	Mã SP Cat. No	Mã Đặt Hàng Order. No	Giá bán/Cái Price/Pc
Tay nắm Nubia Chrome, dài 245 mm, khoách cách bản vít 192mm Nubia Chrome handle, length 245mm, hole spacing 192mm	2	9 106 166	HL 245 - C	395,000
Tay nắm Nubia Inox, dài 245 mm, khoách cách bản vít 192mm Nubia Inox handle, length 245mm, hole spacing 192mm	2	9 105 837	HL 245 - I	395,000

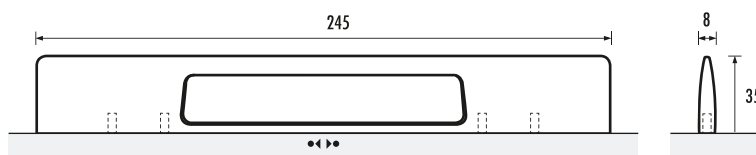

TAY NẮM LAMEZIA
LAMEZIA HANDLE



Mô Tả Description	Nhóm Group	Mã SP Cat. No	Mã Đặt Hàng Order. No	Giá bán/Cái Price/Pc
Tay nắm Lamezia Chrome dài 295 mm, rộng 39mm Lamezia Handles, width 395mm, height 39mm	2	9 105 801	HL 295 - C	150,000
Tay nắm Lamezia Chrome dài 445 mm, rộng 39mm Lamezia Handles, width 395mm, height 39mm	2	9 105 805	HL 445 - C	185,000

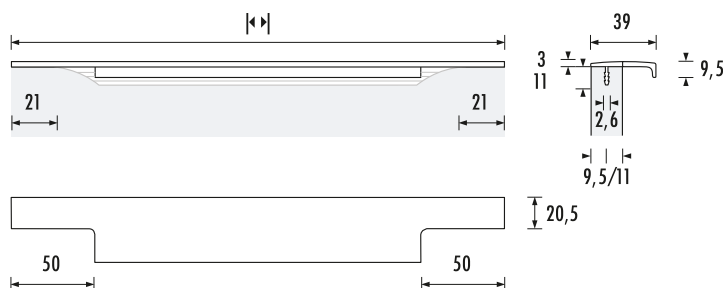

Giá và hình ảnh mang tính chất tham khảo. | The price and pictures is for reference

Bảng giá chưa bao gồm thuế VAT 10% và phí vận chuyển
The prices are not include 10% VAT and transportation fee

► LIFTING COLUMN SYSTEM LEGADRIVE



BỘ PHỤ KIỆN BÀN LEGADRIVE - MÀU BẠC
LEGADRIVE SYSTEMS DESK SUPPORT - SILVER



Mô Tả Description	Nhóm Group	Mã SP Cat. No	Mã Đặt Hàng Order. No	Giá bán/Bộ Price/Set
<p>Bộ hỗ trợ lắp đặt cho bàn tiêu chuẩn Kích thước mặt bàn: - Chiều sâu 800-1000mm - Chiều rộng 1200 -2000mm Tải trọng tối đa : 120 kg Độ cao tùy chỉnh từ 620 - 1295mm Điện thế 230V/50Hz Tốc độ điều chỉnh 40mm/s</p> <p>Basic desk support set For table sizes - Depth 800-1000mm - Width 1200-2000mm Max.lifting capacity 120kg Height adjustment from 620-1295mm Norminal voltage 230V/50Hz Speed 40mm/s</p>	2	9 193 251	TAH - 120	23,500,000

THÔNG SỐ KỸ THUẬT | TECHNICAL DETAILS

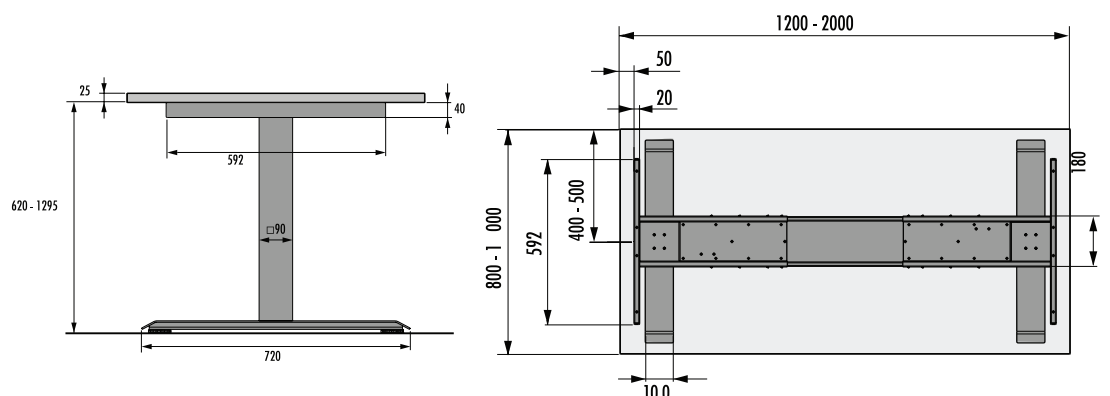

► TRIMANIS TABLE EXTENSION RUNNERS



BỘ PHỤ KIỆN BÀN TRIMANIS DÀI 800 - 1800MM
SÉT OF TRIMANIS TABLE EXTENSION RUNNER, 800 - 1800MM



Mô Tả Description	Nhóm Group	Mã SP Cat. No	Mã Đặt Hàng Order. No	Giá bán/Bộ Price/Set
Ray mở toàn phần cho bàn dài 800-1800mm - 1 bộ Table extension runner for table lengths from 800-1800mm (1 set)	2	9 079 741	TRT - 1800	4,900,000
Bộ phụ kiện thu nắp bàn - 1 bộ Set of retractable flap fitting (1 set)		9 079 783		
Bộ chốt liên kết - 2 bộ Set of dowel and sleeves (2 set)		9 133 060		
Bộ hỗ trợ đỡ mặt bàn khi gấp - 1 bộ Support bracket for folding mechanism - 1 set		9 133 063		
Bản lề âm - 2 cái Internal hinge (2 pcs)		-		

Giá bán không bao gồm 2 cái bản lề âm
 Unit price was excluded 2 concealed hinges.

THÔNG SỐ KỸ THUẬT | TECHNICAL DETAILS

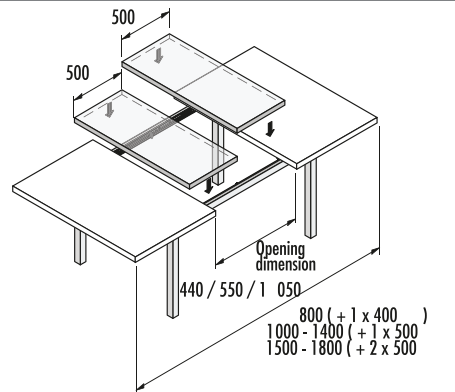

Hiệu lực / Validity : 31.12.2018

TECHNICAL INFORMATION

CALCULATING DOOR WEIGHTS

Weight table for chipboard 19mm

Bảng trọng lượng của ván ép 19mm

Door weight in kg (density = 700kg/m³)

(Trọng lượng cánh (tỷ trọng = 700kg/m³))

Door height mm	Door width mm														
	300	400	500	600	700	800	900	1000	1100	1200	1300	1400	1600	1800	2000
300	1,2	1,6	2,0	2,4	2,8	3,2	3,6	4,0	4,4	4,8	5,2	5,6	6,4	7,2	8,0
400	1,6	2,1	2,7	3,2	3,7	4,3	4,8	5,3	5,9	6,4	6,9	7,5	8,5	9,6	10,6
500	2,0	2,7	3,3	4,0	4,7	5,3	6,0	6,7	7,3	8,0	8,7	9,3	10,6	12,0	13,3
600	2,4	3,2	4,0	4,8	5,6	6,4	7,2	8,0	8,8	9,6	10,4	11,2	12,8	14,4	16,0
700	2,8	3,7	4,7	5,6	6,6	7,5	8,4	9,3	10,2	11,2	12,1	13,0	14,9	16,8	18,6
800	3,2	4,3	5,3	6,4	7,5	8,5	9,6	10,6	11,7	12,8	13,8	14,9	17,0	19,2	21,3
900	3,6	4,8	6,0	7,2	8,4	9,6	10,8	12,0	13,2	14,4	15,6	16,8	19,2	21,6	23,9
1000	4,0	5,3	6,7	8,0	9,3	10,7	12,0	13,3	14,6	16,0	17,3	18,6	21,3	23,9	26,6
1100	4,4	5,9	7,3	8,8	10,2	11,7	13,2	14,6	16,1	17,6	19,0	20,5	23,4	26,3	29,3
1200	4,8	6,4	8,0	9,6	11,2	12,8	14,4	16,0	17,6	19,2	20,8	22,3	25,5	28,7	31,9
1300	5,2	6,9	8,7	10,4	12,1	13,8	15,6	17,3	19,0	20,8	22,5	24,2	27,7	31,1	34,6
1400	5,6	7,5	9,3	11,2	13,0	14,9	16,8	18,6	20,5	22,3	24,2	26,1	29,8	33,5	37,2
1600	6,4	8,5	10,7	12,8	15,0	17,0	19,2	21,3	23,4	25,6	27,7	29,8	34,1	38,3	42,6
1800	7,2	9,6	12,0	14,4	16,8	19,2	21,6	24,0	26,3	28,7	31,1	33,5	38,3	43,1	47,9
2000	8,0	10,6	13,3	16,0	18,6	21,3	23,9	26,6	29,3	31,9	34,6	37,2	42,6	47,9	53,2
2200	8,8	11,7	14,6	17,6	20,5	23,4	26,3	29,3	32,2	35,1	38,0	41,0	46,8	52,7	58,5
2400	9,6	12,8	16,0	19,2	22,3	25,5	28,7	31,9	35,1	38,3	41,5	44,7	51,1	57,5	63,9
2600	10,4	13,8	17,3	20,8	24,2	27,7	31,1	34,6	38,0	41,5	45,0	48,4	55,3	62,2	69,2

Weight table for MDF 19mm

Bảng trọng lượng ván MDF 19 mm

Door weight in kg (density = 900kg/m³)

(Trọng lượng cánh (Tỷ trọng = 900 kg/m³))

Door height (mm) Chiều cao cửa (mm)	Door width (mm) / Chiều rộng cửa (mm)														
	300	400	500	600	700	800	900	1000	1100	1200	1300	1400	1600	1800	2000
300	1,5	2,1	2,6	3,1	3,6	4,1	4,6	5,1	5,6	6,2	6,7	7,2	8,2	9,2	10,3
400	2,1	2,7	3,4	4,1	4,8	5,5	6,2	6,8	7,5	8,2	8,9	9,6	10,9	12,3	13,7
500	2,6	3,4	4,3	5,1	6,0	6,8	7,7	8,6	9,4	10,3	11,1	12,0	13,7	15,4	17,1
600	3,1	4,1	5,1	6,2	7,2	8,2	9,2	10,3	11,3	12,3	13,3	14,4	16,4	18,5	20,5
700	3,6	4,8	6,0	7,2	8,4	9,6	10,8	12,0	13,2	14,4	15,6	16,8	19,2	21,6	23,9
800	4,1	5,5	6,8	8,2	9,6	10,9	12,3	13,7	15,1	16,4	17,8	19,2	21,9	24,6	27,4
900	4,6	6,2	7,7	9,2	10,8	12,3	13,9	15,4	16,9	18,5	20,0	21,6	24,6	27,7	30,8
1000	5,1	6,8	8,6	10,3	12,0	13,7	15,4	17,1	18,8	20,5	22,2	23,9	27,4	30,8	34,2
1100	5,6	7,5	9,4	11,3	13,2	15,1	16,9	18,8	20,7	22,6	24,5	26,3	30,1	32,9	37,6
1200	6,2	8,2	10,3	12,3	14,4	16,4	18,5	20,5	22,6	24,6	26,7	28,7	32,8	36,9	41,0
1300	6,7	8,9	11,1	13,3	15,6	17,8	20,0	22,2	24,5	26,7	28,9	31,1	35,6	40,0	44,5
1400	7,2	9,6	12,0	14,4	16,8	19,2	21,6	23,9	26,3	28,7	31,1	33,5	38,3	43,1	47,9
1600	8,2	10,9	13,7	16,4	19,2	21,9	24,6	27,4	30,1	32,8	35,6	38,3	43,8	49,3	54,7
1800	9,2	12,3	15,4	18,5	21,6	24,6	27,7	30,8	33,9	36,9	40,0	43,1	49,3	55,4	61,6
2000	10,3	13,7	17,1	20,5	23,9	27,4	30,8	34,2	37,6	41,0	44,5	47,9	54,7	61,6	68,4
2200	11,3	15,5	18,8	22,6	26,3	30,1	33,9	37,6	41,4	45,1	48,9	52,7	60,2	67,7	75,2
2400	12,3	16,4	20,5	24,6	28,7	32,8	36,9	41,0	45,1	49,3	53,4	57,5	65,7	73,9	82,1
2600	13,3	17,8	22,2	26,7	31,1	35,6	40,0	44,5	48,9	53,4	57,8	62,2	71,1	80,0	88,9

Adjustment to different material thicknesses

Điều chỉnh độ dày cho các loại vật liệu khác nhau

The table entries refer to 19 mm thick material.
The table entries must be multiplied by a factor in order to adjust to material of different thickness.

Độ dày nguyên liệu Material thickness (mm)	Hệ số Factor
15	0,79
16	0,84
18	0,95
19	1,00
20	1,05
22	1,16
23	1,21
26	1,37
29	1,53

Formula for conversion

Door weight = weight for door in thickness of 19 mm from table above x factor

Example

Chipboard door

H x W x D = 2000 x 1800 x 16

Weight shown in table for this door size, but material in a thickness of 19 mm = 47.9 kg

Convert to 16 mm door thickness using factor of 0.84 as shown in table on left

Door weight = 47.9 kg x 0.84 = 40.2 kg

Calculating weights of doors in alternative door materials

Tính trọng lượng cửa với các loại vật liệu thay thế

Density of various materials in kg/m³

(Tỷ trọng của các loại vật liệu khác nhau. đvt: kg/m³)

Material	Density kg/m ³
Acrylic glass	1200
Aluminium	2700
Balsa wood	120
Concrete	2400
Lead	11300
Iron	7800
Gypsum plasterboard	900
Glass	2600
Hardboard	1000
Hardwood, wet (beech)	900
Hardwood, dry (beech)	800
Cork	300

To calculate the weight of doors in alternative door materials, the specific density of the door material must be taken into consideration.

Example

Door made of acrylic glass with a density of 1200 kg/m³

Door height: 2000 mm, door width: 1800 mm, material thickness: 6 mm

$$\text{Door weight [kg]} = \text{Height [m]} \times \text{Width [m]} \times \text{Material thickness [m]} \times \text{Density [kg/m}^3\text{]}$$

25,9 kg = 2 × 1,8 × 0,006 × 1200

ORDER NUMBER INDEX

Mã Sản Phẩm Item No.	Mã Đặt Hàng Order No.	Trang Page
0 000 837	TLS719-25	55
0 004 292	SLS056-40	66
0 004 311	WL770-80B	63
0 004 312	WL770-80B	63
0 004 316	TLS019-50	51
0 004 317	TLS019-50	51
0 004 343	AP019-04	67
0 004 344	AP019-01	67
0 004 345	AP019-03	67
0 004 346	AP019-02	67
0 004 369	LB100-03	72
0 005 009	WL230-100	57
0 013 308	OT900-S2	73
0 024 369	LB100-06	72
0 026 082	TLS719-25	55
0 040 301	HD165-F	13
0 044 945	OT900-S1	73
0 045 036	HD065-F	13
0 045 062	HC065-I	72
0 045 080	TLS719-25	55
0 045 234	SLS056-40	66
0 046 417	TLS719-25	55
0 046 419	TLS019-4D	53
0 047 661	SS661-S	81
0 049 474	RR474-P	71
0 060 200	HD110-F	13
0 060 201	HD110-H	13
0 060 202	HD110-I	13
0 060 230	PA109-W	19
0 060 231	PA109-C	19
0 060 233	PA209-A	19
0 060 576	SI518-F	18
0 060 577	SI620-H	18
0 060 578	SI922-I	18
0 060 581	SI007-A	18
0 060 685	SI007-W	18
0 060 687	SI007-C	18

Mã Sản Phẩm Item No.	Mã Đặt Hàng Order No.	Trang Page
0 061 851	KL100-B	72
0 061 854	KL100-B	72
0 061 855	KL100-K	72
0 066 900	SL055-15	66
0 070 659	WS455-C	70
0 070 799	SH005-S	76
0 070 800	SH005-S	76
0 070 820	SH005-D	76
0 070 968	WL770-80B	63
0 070 969	WL770-80B	63
0 071 110	SLS056-40	66
0 071 111	TLS019-50	51
0 071 117	TLS019-50	51
0 072 919	WL770-80B	63
0 072 947	HS165-F	13
0 073 347	SD026-M	71
0 073 504	CO504-L	78
0 073 505	CO504-R	78
0 074 848	SH005-S	76
0 077 708	HD000-F	14
0 079 015	WL230-100	57
0 079 717	HC055-B	72
0 115 090	HL200-P	86
0 115 298	HL200-SE	86
0 115 314	HL200-S	86
1 004 928	SP010-M6	81
1 012 777	HB099-A1	72
1 029 518	HS110-F	13
1 030 620	HS110-H	13
1 030 922	HS110-I	13
1 062 019	ITSS1-070	27
1 062 020	ITSS1-070	27
1 062 394	ITSB1-144	27
1 062 454	ITWS1-070	31
1 062 455	ITWS1-070	31
1 062 501	ITSA1-070	23
1 062 502	ITSA1-070	23

Mã Sản Phẩm Item No.	Mã Đặt Hàng Order No.	Trang Page
1 062 503	ITWS1-070	31
1 062 504	ITWS1-070	31
1 062 549	ITWB1-144	31
1 065 191	ITWS1-070	31
1 071 606	SP110-I	14
1 073 723	BB400-F	41
1 073 724	BB450-F	41
1 073 725	BB500-F	41
1 074 008	ITWB2-144	33
1 074 009	ITSB2-144	29
1 074 018	BB250-F	41
1 074 019	BB300-F	41
1 074 020	BB350-F	41
1 078 660	HE095-F	17
1 078 661	HE095-H	17
1 078 662	HE095-I	17
1 079 089	WL770-80B	63
1 079 198	SP095-I	17
1 079 849	WL230-100	57
1 081 483	QN400-F	39
1 081 484	QN400-F	39
1 081 486	QN500-F	39
1 081 487	QN500-F	39
1 083 703	QN450-F	39
1 083 704	QN450-F	39
1 084 459	QN350-F	39
1 084 460	QN350-F	39
9 002 503	ITWB1-144	31
9 005 267	OS500-G	73
9 005 269	OS800-G	73
9 007 355	ITSB1-144	27
9 007 356	ITSB1-144	27
9 027 831	ITSB1-176	28
9 027 832	ITSB1-176	28
9 038 031	SP010-E5	81
9 047 861	TS030-E5	81
9 047 865	TS030-M6	81

Mã Sản Phẩm Item No.	Mã Đặt Hàng Order No.	Trang Page
9 047 975	TS020-E5	81
9 056 601	RT015-18	81
9 060 648	ITWB1-144	31
9 060 649	ITWB1-144	31
9 064 684	RT015-15	81
9 065 857	CI200-17	77
9 065 860	CI300-20	77
9 065 861	CI200-17	77
9 065 862	CI300-20	77
9 071 205	HP110-F	10
9 071 206	HP110-H	10
9 071 207	HP110-I	10
9 071 259	HPN110-F	10
9 071 260	HPN110-H	10
9 071 261	HPN110-I	10
9 071 576	SP110-S	11
9 071 651	SP110-P	11
9 077 588	CI150-15	77
9 077 601	CI150-15	77
9 078 139	AU001-E	80
9 079 172	OT400-S1	73
9 079 173	OT500-S4	73
9 079 220	ITSS1-070	27
9 079 593	PI080-N	46
9 079 603	LA276-HKS	45
9 079 610	LA611-HFS	45
9 079 614	LA701-HFS	45
9 079 615	LA771-HFS	45
9 079 619	LA200-P	45
9 079 624	LA300-P	45
9 079 628	LA400-P	45
9 079 630	LA450-P	45
9 079 632	LA500-P	45
9 079 635	LA550-P	45
9 079 637	LA600-P	45
9 079 645	LA700-P	45
9 079 650	LA800-P	45

ORDER NUMBER INDEX

Mã Sản Phẩm Item No.	Mã Đặt Hàng Order No.	Trang Page
9 079 710	AU001-E	80
9 079 731	SS056-40	66
9 079 733	ST719-25	55
9 079 741	TRT-1800	89
9 079 783	TRT-1800	89
9 079 810	BS600-W	70
9 079 811	BS800-W	70
9 079 812	BS900-W	70
9 079 864	SH005-D	76
9 079 941	CC02-3/4	79
9 079 960	WS600-T	70
9 079 963	WS100-T	70
9 079 970	RR970-I	71
9 080 011	CO504-R	78
9 080 040	RV90-02	79
9 080 043	RV90-02	79
9 080 089	SH005-S	76
9 080 150	SH005-D	76
9 082 356	AU001-E	80
9 082 357	AU001-E	80
9 082 360	AU001-E	80
9 082 363	AU001-E	80
9 082 364	AU001-E	80
9 082 365	AU001-E	80
9 082 614	SP110-C	11
9 082 774	SP110-B	11
9 083 438	CO504-R	78
9 083 442	CO504-L	78
9 083 798	SH005-D	76
9 086 247	ITSB2-144	29
9 086 687	HL181-I	85
9 086 688	HL181-C	85
9 086 689	HR690-I	84
9 086 690	HR690-C	84
9 086 691	HL691-I	85
9 086 692	HL692-C	85
9 086 693	HR693-I	84

Mã Sản Phẩm Item No.	Mã Đặt Hàng Order No.	Trang Page
9 086 694	HR694-C	84
9 086 714	AU001-E	80
9 086 932	ITWB1-176	32
9 086 933	ITWB1-176	32
9 089 602	PA209-B	19
9 090 137	SP110-B	11
9 090 138	SP110-C	11
9 090 260	HP032-F	10
9 090 270	HP032-H	10
9 090 280	HP032-I	10
9 090 350	HPN032-F	10
9 090 360	HPN032-H	10
9 090 370	HPN032-I	10
9 091 738	HB110-F	9
9 091 739	HB110-H	9
9 091 740	HB110-I	9
9 091 800	SP110-SB	9
9 091 821	SP110-BB	9
9 091 822	SP110-CB	9
9 097 922	AU001-E	80
9 097 923	AU001-E	80
9 098 724	ITWG1-144	32
9 099 750	HS165-F	13
9 100 852	AU001-E	80
9 100 878	ITSG1-144	28
9 100 882	ITWG1-144	32
9 104 095	ITWS1-070	31
9 104 107	ITSS2-070	29
9 104 108	ITWS2-070	33
9 104 118	ITSB2-144	29
9 105 801	HL295-C	87
9 105 805	HL445-C	87
9 105 837	HL245-I	87
9 106 166	HL245-C	87
9 106 449	AU001-E	80
9 110 993	ITSG1-176	28
9 110 997	ITWG1-176	32

Mã Sản Phẩm Item No.	Mã Đặt Hàng Order No.	Trang Page
9 113 830	OT900-W1	73
9 113 861	OT500-W3	73
9 114 915	ITWB2-144	33
9 115 217	SL055-15	66
9 115 218	SL055-15	66
9 115 219	SL055-15	66
9 115 501	ITWS2-070	33
9 115 502	ITWB2-144	33
9 116 018	RT015-12	81
9 117 214	SH005-S	76
9 117 223	SH005-S	76
9 118 054	ITWS1-070	31
9 118 055	ITWS1-070	31
9 128 579	BS300-F	41
9 128 580	BS350-F	41
9 128 581	BS400-F	41
9 128 582	BS450-F	41
9 128 583	BS500-F	41
9 129 901	BS025-01	67
9 131 416	HL180-C	86
9 132 399	LMII-2L	78
9 132 400	LMII-2R	78
9 132 546	LMII-2L	78
9 133 060	TRT-1800	89
9 133 063	TRT-1800	89
9 136 121	AP019-01	67
9 136 151	LMII-2L	78
9 136 152	LMII-2R	78
9 140 438	ST019-CD	52
9 144 830	RS002-A	40
9 144 841	RS002-A	40
9 146 622	AP019-02	67
9 146 624	AP019-03	67
9 148 203	IL1199-060	49
9 148 547	IL1199-060	49
9 155 241	HD043-F	14
9 155 242	HD043-H	14

Mã Sản Phẩm Item No.	Mã Đặt Hàng Order No.	Trang Page
9 155 243	HD043-I	14
9 156 338	KD770-MA	65
9 169 637	ST019-4A	53
9 169 651	ST019-50A	51
9 169 653	ST019-3DA	52
9 185 715	TLS019-4D	53
9 193 251	TAH-120	88
9 194 398	ITSA1-070	23
9 194 399	ITSA1-070	23
9 194 530	ITSA1-144	23
9 194 531	ITSA1-144	23
9 194 570	ITSA2-144	24
9 194 571	ITSA2-144	24
9 194 614	ITSA2-144	24
9 194 646	ITSA1-070	23
9 194 764	ITSA2-070	24
9 195 018	ITSA1-176	23
9 195 019	ITSA1-176	23
9 199 769	TLS019-4D	53
9 203 401	AT250-4F	37
9 203 403	AT300-4F	37
9 203 405	AT350-4F	37
9 203 407	AT400-4F	37
9 203 408	AT400-6F	37
9 203 411	AT450-4F	37
9 203 412	AT450-6F	37
9 203 415	AT500-4F	37
9 203 416	AT500-6F	37
9 203 421	AT550-4F	37
9 203 422	AT550-6F	37
9 204 257	ITSA2-144	24
9 206 309	TLS019-4D	53
9 206 310	TLS019-3D	52
9 206 500	TLS019-4D	53
9 206 502	TLS019-50	51
9 206 505	TLS019-4D	53
9 206 506	TLS019-4D	53

ORDER NUMBER INDEX

Mã Sản Phẩm Item No.	Mã Đặt Hàng Order No.	Trang Page
9 208 645	HC065-I	72
9 208 646	HC065-I	72
9 208 678	HB099-A2	72
9 209 226	KD770-MA	65
9 209 278	KD770-MA	65
9 212 301	AT001-P	37
9 214 815	HP110-F	10
9 214 816	HP110-H	10
9 214 837	HP110-I	10
9 214 840	SP110-S	11
9 221 513	BS300-F	41
9 221 525	BS350-F	41
9 221 526	BS400-F	41
9 221 527	BS450-F	41
9 221 528	BS500-F	41
9 225 570	LGM-736	46
9 227 549	LGM-736	46
9 237 880	WLPS25-4	60
9 237 881	WLPS25-4	60
9 238 052	WLPS25-4	60
9 238 053	WLPS25-4	60
9 238 114	WLPL25-4	61
9 238 125	WLPL25-4	61
9 239 310	WLPS25-4	60
9 246 564	QS400-F23	39
9 246 565	QS400-F23	39
9 246 739	QS300-P23	39
9 246 740	QS300-P23	39
9 246 742	QS350-P23	39
9 246 743	QS350-P23	39
9 246 744	QS400-P23	39
9 246 745	QS400-P23	39
9 246 747	QS450-P23	39
9 246 748	QS450-P23	39
9 246 750	QS500-P23	39
9 246 751	QS500-P23	39
9 246 754	QP300-P23	40

Mã Sản Phẩm Item No.	Mã Đặt Hàng Order No.	Trang Page
9 246 755	QP300-P23	40
9 246 756	QP350-P23	40
9 246 757	QP350-P23	40
9 246 758	QP400-P23	40
9 246 759	QP400-P23	40
9 246 760	QP450-P23	40
9 246 761	QP450-P23	40
9 246 762	QP500-P23	40
9 246 763	QP500-P23	40
9 246 868	QS300-F23	39
9 246 869	QS300-F23	39
9 246 871	QS350-F23	39
9 246 872	QS350-F23	39
9 246 875	QS450-F23	39
9 246 876	QS450-F23	39
9 246 889	QS500-F23	39
9 246 890	QS500-F23	39
9 246 895	QP300-F23	40
9 246 896	QP300-F23	40
9 246 897	QP350-F23	40
9 246 898	QP350-F23	40
9 246 899	QP400-F23	40
9 246 900	QP400-F23	40
9 246 901	QP450-F23	40
9 246 902	QP450-F23	40
9 246 903	QP500-F23	40
9 246 904	QP500-F23	40
CC015-B	CC015-B	81
CC015-P	CC015-P	81
CC015-W	CC015-W	81



VIETNAM OFFICES

An Cuong Showhouse
279 Nguyen Van Troi Str, Ward 10,
Phu Nhuan District, Ho Chi Minh City
T (84.28) 3844 1884
F (84.28) 3997 0135
E infoacc@ancuong.com

An Cuong Head Office
702/1K, Su Van Hanh Street, Ward 12,
District 10, Ho Chi Minh City, Vietnam
T (84.28) 3862 5726
F (84.28) 3862 5727
E infoacc@ancuong.com

An Cuong Show Gallery & Design Center
702/3F, Su van Hanh Street,
Ward 12, District 10, Ho Chi Minh City
T (84.28) 3862 7414
F (84.28) 3868 4197
E infoacc@ancuong.com

An Cuong Show Depot 1
162 Tan Huong, Tan Quy Ward,
Tan Phu District, Ho Chi Minh City
T (84.28) 3847 2078
F (84.28) 3847 2068
E infoacc@ancuong.com

An Cuong Show Depot 2
Section No. 2, Lot 5-1, M12 Street,
Extended Tan Binh Industrial zone, Binh Hung Hoa ward,
Binh Tan District, Ho Chi Minh City
T (84.28) 3620 5633
F (84.28) 3620 5636

An Cuong Factory Outlet
DT 747 B Phuoc Hai, Thai Hoa,
Tan Uyen, Binh Duong, Vietnam
T (84.274) 3626 282
F (84.274) 3626 284
E infoacc@ancuong.com

Ha Noi Show Gallery & Design Center
Villa C4-N08-B, the new urban area Dich Vong,
Cau Giay District, Ha Noi, Vietnam
T (84.24) 6281 4719
F (84.24) 6281 4729
E infoacc@ancuong.com

Ha Noi Showhouse
10 Chuong Duong Do Street,
Hoan Kiem District, Ha Noi, Vietnam
T (84.24) 6281 4719
F (84.24) 6281 4729
E infoacc@ancuong.com

Da Nang Office & Showroom
2nd Floor, 112 Nguyen Huu Tho,
Hoa Thuan Tay Ward, Hai Chau District,
Da Nang, Vietnam
T (84.236) 362 5727
F (84.236) 362 5729
E infoacc@ancuong.com

Da Nang Showhouse
75 Hoang Dieu Street,
Hai Chau District, Da Nang, Vietnam
T (84.236) 362 5727
F (84.236) 362 5729
E infoacc@ancuong.com

INTERNATIONAL OFFICES

Malaysia Office & Showroom
B2-12-2 Dataran Niaga SG Besi,
Midfields Square East, Jin 11/108C,
57100 Kuala Lumpur
T +60 12 290 6486
E infoacc@ancuong.com

Japan Office via Sumitomo Forestry Group
Timber & Building Materials Division
Business Planning Department
1-3-2 Otemachi, Chiyoda-Ku
Tokyo 100-8270, Japan
T +81 3 3214 3280
E infoacc@ancuong.com

Australia Office
35 Keira Street, Port Kembla, NSW, 2505
T +61 (0)41 407 2099
E infoacc@ancuong.com

Canada Office via Zen living
Bay 1- 4216 61 Avenue S.E
Calgary Alberta Canada, T2C 1S5
T +1 403 720 928
E infoacc@ancuong.com

America Office
752 Breen Ct
Woodland CA 95776, USA
T +1 916 807 0475
E infoacc@ancuong.com

Cambodia Office & Showroom
S.I Building, # 93, Preah Sihanouk Blvd,
Phnom Penh
T +855 97 457 7658
E infoacc@ancuong.com

www.ancuong.com

www.facebook.com/ancuongcompany